

# ***Shark* VACMOP®**

## **Cordless Hard Floor System**

QM250/VM250 Series

**OWNER'S GUIDE**

---



# IMPORTANT SAFETY INSTRUCTIONS

PLEASE READ ALL INSTRUCTIONS BEFORE USING THIS PRODUCT.

If the charging cord plug does not fit fully into the outlet, reverse the plug. If it still does not fit, contact a qualified electrician. DO NOT force into outlet or try to modify to fit.

## WARNING

To reduce the risk of fire, electric shock, injury, or property damage:

When using an electrical appliance, basic precautions should always be followed, including the following:

### THIS PRODUCT CONTAINS ELECTRICAL CONNECTIONS:

1. Use only as described in this manual. **DO NOT** use the Shark VACMOP™ for any purpose other than those described in this manual.
2. These components contain electrical connections, electrical wiring, and moving parts that potentially present risk to the user.
3. Before each use, carefully inspect all parts for any damage. If a part is damaged, discontinue use.
4. Use only identical replacement parts.
5. This Shark VACMOP contains no serviceable parts.
6. **DO NOT** immerse or spray water on the body of the Shark VACMOP. To clean the surface, wipe with a dry cloth.
7. Keep the appliance and its charging cord out of reach of children. **DO NOT** allow the appliance to be used by children. Do not allow to be used as a toy. Close supervision is necessary when used near children.

### GENERAL USE

8. This appliance can be used by persons with reduced physical, sensory or mental capabilities or lack of experience and knowledge if they have been given supervision or instruction concerning use of the appliance in a safe way and understand the hazards involved. Cleaning and user maintenance shall not be made by children. Always turn off the Shark VACMOP before connecting or disconnecting any current carrying hoses, chargers, batteries, or other electrical or mechanical parts.
9. **DO NOT** handle plug or Shark VACMOP with wet hands.
10. **DO NOT** use without Shark VACMOP disposable pad attached.
11. Only use Shark® branded Shark VACMOP disposable pads.
12. **DO NOT** put any objects into Shark VACMOP base. **DO NOT** use with any opening blocked; keep free of dust, lint, hair, and anything that may reduce airflow.
13. **DO NOT** use if Shark VACMOP base airflow is restricted. If the air paths or the Shark VACMOP base become blocked, turn the Shark VACMOP off. Remove all obstructions before you turn on the unit again.
14. Keep all Shark VACMOP base openings away from hair, face, fingers, uncovered feet, or loose clothing.
15. **DO NOT** use if Shark VACMOP is not working as it should, or has been dropped, damaged, left outdoors, or dropped into water.
16. Use extra care when cleaning on stairs.
17. **DO NOT** place Shark VACMOP on unstable surfaces such as chairs or tables.

18. **DO NOT** use to pick up:
  - a) Large quantities of dust (including drywall, fireplace ash, or embers).
  - b) Smoking or burning objects (hot coals, cigarette butts, or matches)
  - c) Flammable or combustible materials (lighter fluid, gasoline, or kerosene)
  - d) Toxic materials (chlorine bleach, ammonia, or drain cleaner)
19. **DO NOT** use in the following areas:
  - a) Poorly lit areas
  - b) Outdoor areas
  - c) Spaces that are enclosed and may contain explosive or toxic fumes or vapors (lighter fluid, gasoline, kerosene, paint, paint thinners, mothproofing substances, or flammable dust)
20. Release all operational triggers on the Shark VACMOP before plugging in or unplugging the charger.
21. Release all operational triggers on the Shark VACMOP before any adjustment, cleaning, maintenance or troubleshooting.
22. **DO NOT** modify or attempt to repair the Shark VACMOP or the battery yourself, except as indicated in this manual. **DO NOT** use the battery or Shark VACMOP if it has been modified or damaged. Damaged or modified batteries may exhibit unpredictable behavior resulting in fire, explosion or risk of injury.
23. Always release all operational triggers on this appliance before attaching or detaching a Shark VACMOP disposable pad.

### BATTERY

24. The battery is the power source for the Shark VACMOP. Carefully read and follow all charging instructions.
25. To prevent unintentional starting, **DO NOT** carry the appliance with your finger on the trigger or spray button.
26. Use only Shark® standard replacement charger. Use of an incorrect charger may result in no charging, and/or unsafe conditions. A charger that is suitable for one type of battery may create a risk of fire when used with another battery.
27. Keep the battery away from all metal objects such as paper clips, coins, keys, nails, or screws. Shorting the battery terminals increases the risk of fire or burns.
28. Under abusive conditions, liquid may be ejected from the battery. Avoid contact with this liquid, as it may cause irritation or burns. If contact occurs, flush with water. If liquid contacts eyes, seek medical help.
29. Battery should not be stored at temperatures below 37.4°F (3°C) or above 104°F (40°C) to maintain long-term battery life.
30. **DO NOT** charge battery at temperatures below 40°F (5°C) or above 104°F (40°C). Charging improperly or at temperatures outside of the specified range may damage the battery and increase the risk of fire.
31. Store the appliance indoors. **DO NOT** use or store it below 37.4°F (3°C). Ensure the appliance is at room temperature before operating.
32. **DO NOT** expose the battery to fire or temperatures above 265°F (130°C) as it may cause explosion.
33. Not for wet pickup.
34. Use only Shark brand cleaning fluids.

## SAVE THESE INSTRUCTIONS

## ASSEMBLY

Your Shark VACMOP™ unit comes partially assembled with a cord connecting the parts. All versions assemble the same way. This appliance is for Household use only.

1. Align and insert the **Handle** into the top of the **Pole**. You will feel it click in place.
2. Align and insert the pole into the **Main Body**. You will feel it click in place.

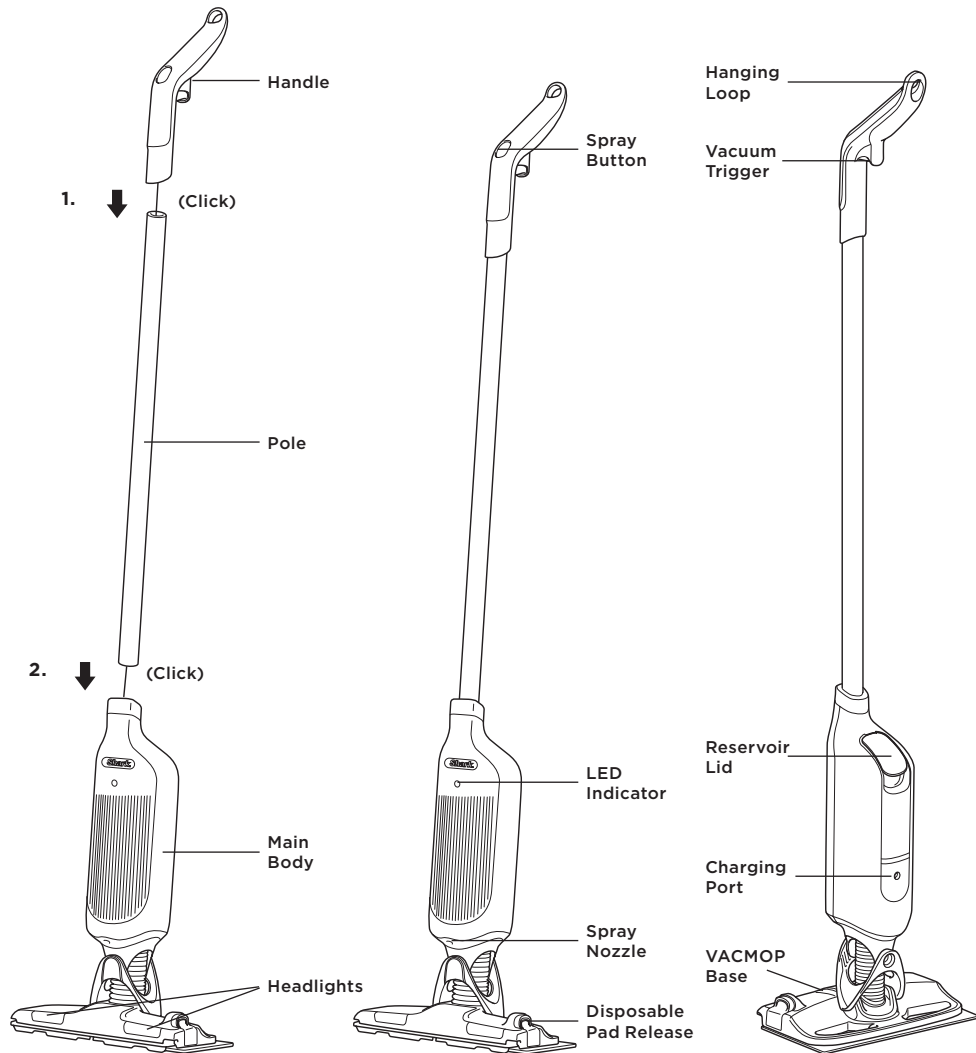

**NOTE:** The model and serial numbers can be found on the QR code label on the back on the main body.

## CHARGING THE LI-ION BATTERY

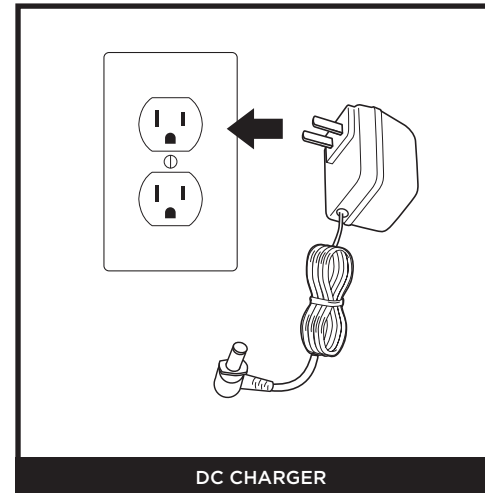

Plug charger into an electrical outlet.

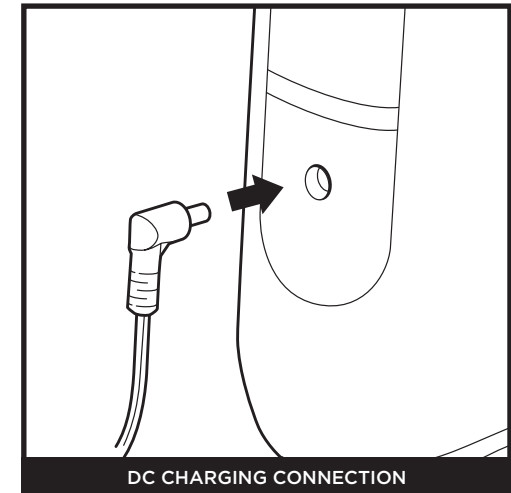

Plug the charger into the port on the back of the main body.

## CONTROLS

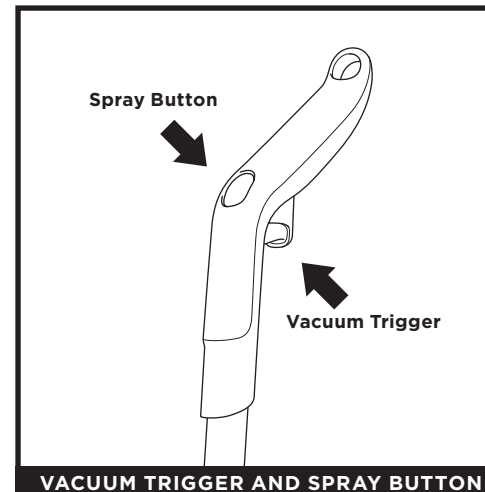

**Spray Button**  
Press and hold the spray button on top of the handle to dispense cleaning solution through the spray nozzle.

**Vacuum Trigger**  
To vacuum, pull the trigger and hold it in.

**NOTE:** The spray button and vacuum trigger cannot be activated at the same time.

## HEADLIGHTS

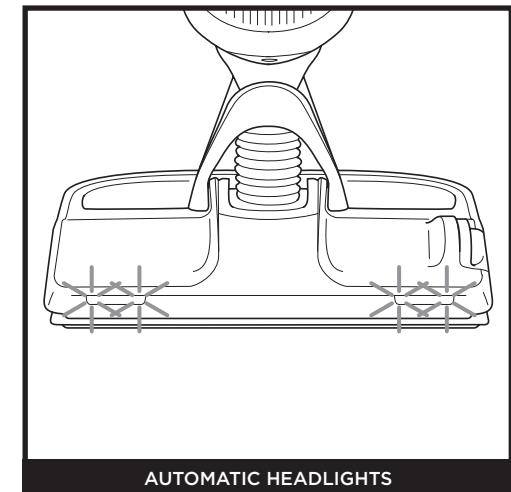

When the VACMOP™ is in use, the motion sensor will automatically activate the headlights. After 10 seconds of inactivity, the headlights will turn off.

## ATTACHING AND REMOVING THE DISPOSABLE PADS

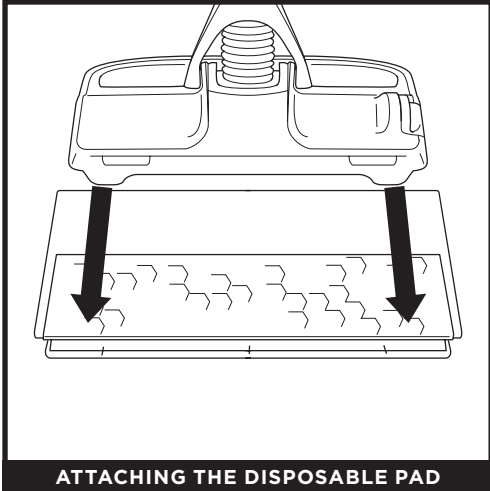

**ATTACHING THE DISPOSABLE PAD**

Place the Shark VACMOP™ Disposable Pad on the floor with the scrubbing strip down. Line up the front edge of the Shark VACMOP into the plastic bumper on the pad. Holding the handle, press the Shark VACMOP base down until the disposable pad clicks into place.



**REMOVING THE DISPOSABLE PAD**

To detach the disposable pad, press the release button on the side of the Shark VACMOP base. Dispose of dirty pads by releasing them directly into the trash.

## DISPOSABLE PAD FUNCTIONALITY

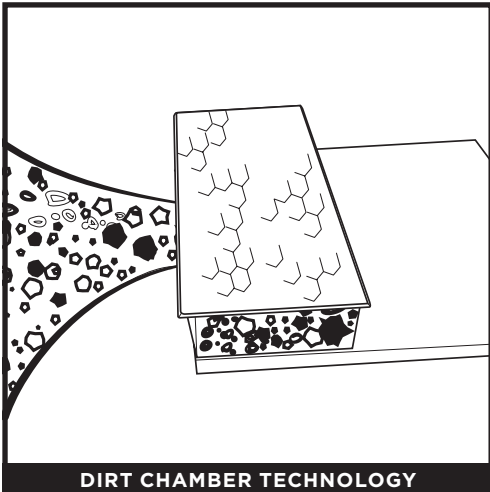

**DIRT CHAMBER TECHNOLOGY**

The dirt chamber collects and locks away dirt and debris when you vacuum.

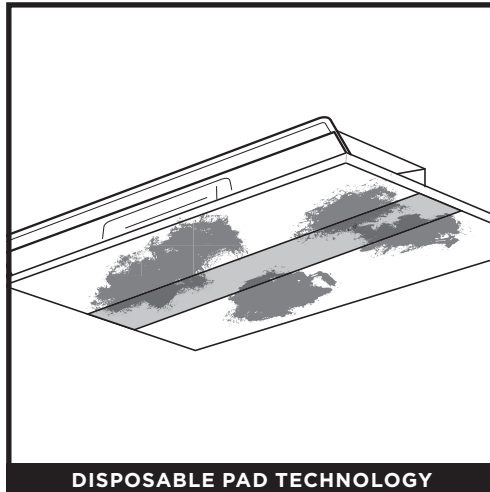

**DISPOSABLE PAD TECHNOLOGY**

The disposable pad's fibers absorb messes as you mop.

**NOTE: DO NOT** vacuum up liquid or vacuum while spraying cleaner—this will cause reduced suction or no suction. Clean liquids and wet messes **ONLY** by mopping.

## LI-ION BATTERY

Prior to first use, charge completely. A full charge takes approximately 3.5 hours.

### BATTERY RUNTIME

The Shark VACMOP™ is designed to handle anything from quick pickups to whole cleaning sessions—just charge it between uses. If it's used for one-off everyday messes or for more mopping than vacuuming, it will last longer on one charge. If you're continuously vacuuming, a full charge will last up to 13 minutes.

### LED BATTERY POWER AND CHARGING INDICATOR

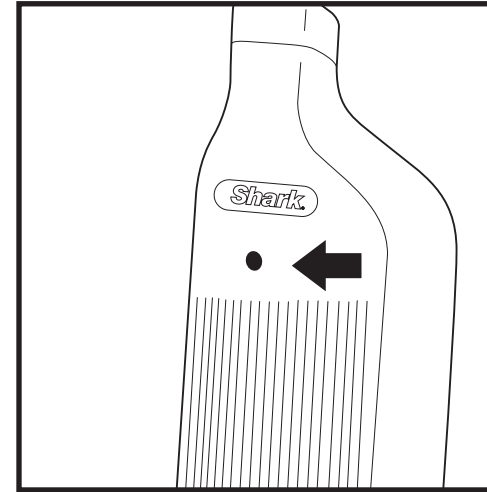

#### Indicator LED

##### IN USE:

**Normal Operation** - Solid white

**Low Battery** - Blinking white

**Very Low Battery** - Blinking red

**Out of battery** - Rapid blinking red

##### CHARGING:

**Battery Charging** - Pulsing white

**Full Charge** - Solid white  
(will turn off after 5 minutes)

### RECYCLING THE LI-ION BATTERY

When the Shark® Li-Ion battery needs to be replaced, dispose of it or recycle it in accordance with local ordinances or regulations. In some areas, it is illegal to place spent lithium-ion batteries in the trash or in a municipal solid waste stream. Return spent batteries to an authorized recycling center or to the retailer for recycling. Contact your local recycling center for information on where to drop off the spent battery.

**NOTE:** The Shark battery, like all lithium-ion batteries, will naturally decrease in capacity over time from the 100% capacity of a new battery.

## FILLING THE RESERVOIR

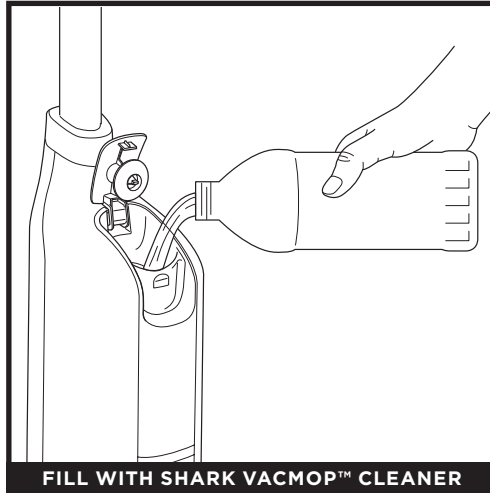
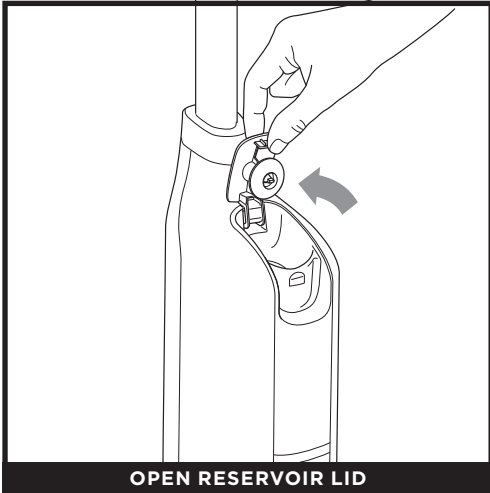

Lift the reservoir lid and press it up until it clicks into the open locked position. Carefully pour Shark VACMOP Cleaner into the reservoir, up to the **MAX** line. When finished, press the lid closed.

**NOTE:** Before using your unit for the first time, carefully add the entire starter bottle of Shark VACMOP Cleaner into the reservoir. New units may have residual moisture in tank from quality testing.

## CLEANING MODES

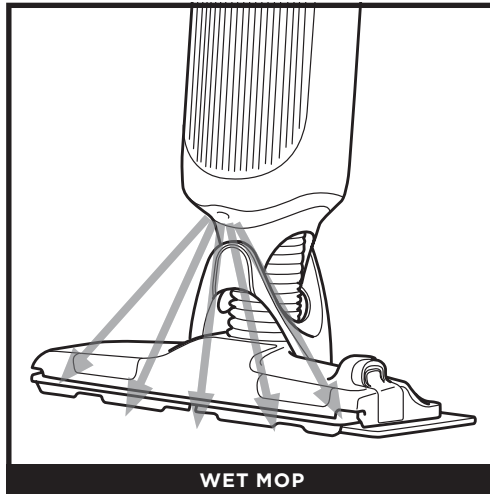
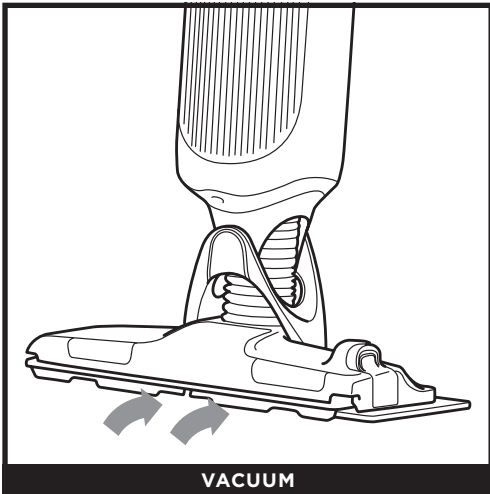

For best results, first use the vacuum to remove dry debris, then spray the Shark VACMOP Cleaner to wet mop.

## STORAGE

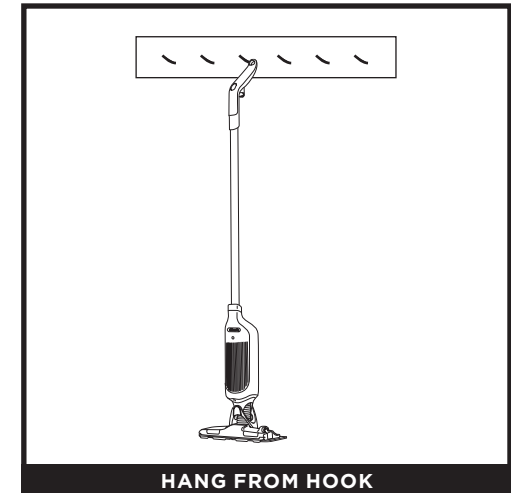
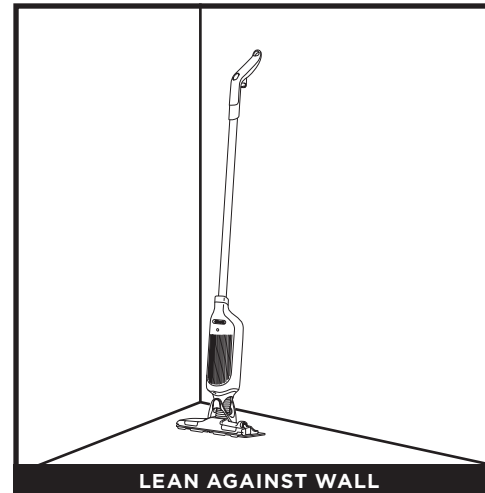

After wet cleaning, remove the pad from the Shark VACMOP™ base before storing the unit.

To store the unit, stand it upright and lean the back of the non-slip handle against a wall.

To hang the unit from a nail or wall hook (not included) align the opening at the end of the handle over the hook or nail.

## DISASSEMBLY

**NOTE:** Once the unit is assembled, do not take it apart, unless for repacking or shipping.

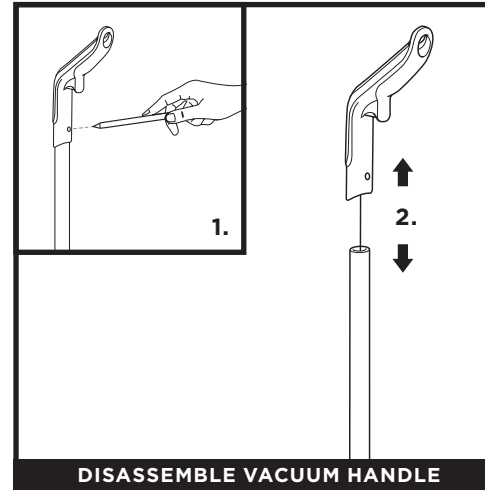

1. Press in the snap clip with a small tool (screwdriver, pen, etc.)
2. While pressing down on the top snap clip, pull the handle out of the pole.

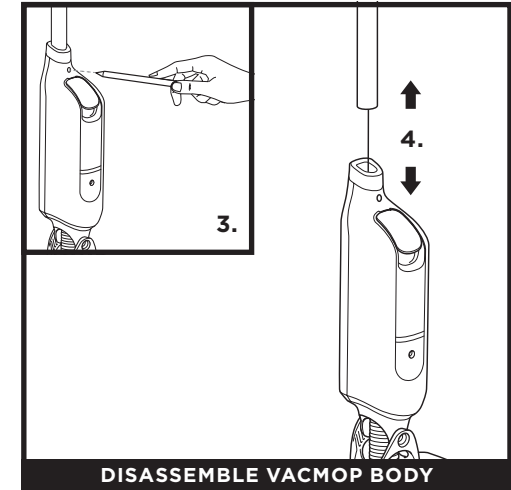

3. Next, press in the snap clip on the Shark VACMOP body with a small tool.
4. While pressing down on the bottom snap clip, pull the pole out of the Shark VACMOP body.

## MAINTAINING YOUR VACUUM

### TROUBLESHOOTING

#### **Shark VACMOP™ is not picking up debris. No suction or light suction.**

- The dirt chamber filter on the disposable pad may be saturated. Try using a new pad.  
**Note: DO NOT** vacuum up liquid or wet debris—this will cause reduced suction or no suction. Remove liquids and wet messes **ONLY** by mopping.
- VACMOP Disposable Pad may not be securely attached. Reattach the pad.
- VACMOP Disposable Pad may be full of debris and need to be replaced.
- Battery charge may be low. Recharge the battery completely.

#### **The unit turns off on its own. Sprayer is not spraying.**

- Make sure there is enough cleaning solution in the reservoir. Battery charge may be low. Recharge the battery completely.

#### **Streaks appear on floor after wet mopping.**

- Shark VACMOP Cleaner has been specially formulated to provide a residue-free, streak-free finish when used with the Shark VACMOP. Using other cleaning solutions may result in streaking and residue. If you find residue or streaking on your floors while using our cleaner, it may be due to one of the following:
- Your floor might not be fully dry yet. If you see streaks or suds while cleaning, just wait 5-10 minutes, and you should see them evaporate, leaving an even finish on your floors.
- Your floors might have built-up grime and dirt. The first few times you use your VACMOP, it will remove stuck-on dirt and debris that have built up over time. After a few cleaning sessions, the streaking and residue will subside.
- You may be using too much solution. If you continue to see streaking, reduce the amount of cleaning solution you use. Too much solution can cause stickiness and residue if not properly cleaned off of your floor.
- The disposable pad might need to be replaced. If you are cleaning multiple times with the same pad, you may be reintroducing dirt onto the floors. Replace your pad, and consider starting each mopping session with a fresh pad to alleviate the issue.

#### **The unit makes scraping sounds when mopping.**

- Debris may be stuck on the face of the pad. Detach the pad and remove any embedded debris.
- The pad face may be rubbing against a rough or grainy surface. This will not damage your floors.
- If your floor is uneven, the dirt chamber on the pad could be brushing against a raised section of the floor. This will not damage your floors.
- Scrubbing forcefully can bring the dirt chamber in contact with the floor. This will not damage your floors.
- Moving the handle when spraying could cause the front of the VACMOP base to drag. This will not damage your floors.

### FREQUENTLY ASKED QUESTIONS

#### **When should I replace my Shark VACMOP Disposable Pad?**

- Replace the disposable pad when it becomes fully saturated, its dirt chamber is full, it is noticeably dirty, or if the VACMOP is showing signs of reduced suction power.

#### **Where can I use my Shark VACMOP?**

- Shark VACMOP can safely be used on all sealed hard floors—stone, hardwood, vinyl, laminate, tile, marble, and linoleum.

#### **Can I vacuum and mop with the same disposable pad?**

- Shark VACMOP Disposable Pads can be used for both mopping and vacuuming. The dirt chamber collects and locks away dirt and debris when you vacuum, while the pad's fibers absorb messes as you mop. Dust and debris collected on the pad when vacuuming will be absorbed when mopping.

## ADDITIONAL ACCESSORIES AVAILABLE ON SHARKCLEAN.COM/VACMOP

### WHAT'S INCLUDED

- A** Shark VACMOP™ Disposable Pads
- B** Shark VACMOP Cleaner
- C** Replacement DC Charger

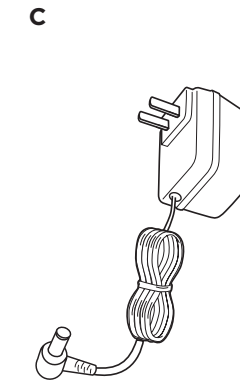
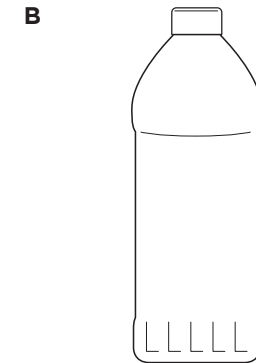
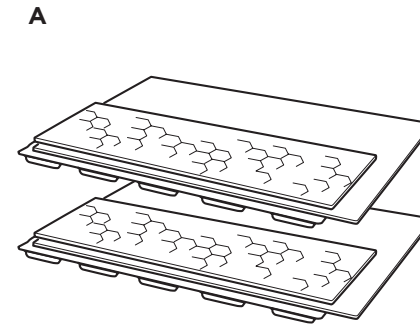

**NOTE:** Not all accessories come with all units. Please see the on box Quick Start Guide for your unit's configuration. To order additional accessories, visit [sharkaccessories.com](https://sharkaccessories.com).

## ONE (1) YEAR LIMITED WARRANTY

The One (1) Year Limited Warranty applies to purchases made from authorized retailers of **SharkNinja Operating LLC**. Warranty coverage applies to the original owner and to the original product only and is not transferable.

SharkNinja warrants that the unit shall be free from defects in material and workmanship for a period of one (1) year from the date of purchase when it is used under normal household conditions and maintained according to the requirements outlined in the Owner's Guide, subject to the following conditions and exclusions:

### What is covered by this warranty?

1. The original unit and/or non-wearable parts deemed defective, in SharkNinja's sole discretion, will be repaired or replaced up to one (1) year from the original purchase date.
2. In the event a replacement unit is issued, the warranty coverage ends six (6) months following the receipt date of the replacement unit or the remainder of the existing warranty, whichever is later. SharkNinja reserves the right to replace the unit with one of equal or greater value.

### What is not covered by this warranty?

1. Normal wear and tear of wearable parts (such as Shark Cleaner, Pad, etc.), which require regular maintenance and/or replacement to ensure the proper functioning of your unit, are not covered by this warranty. Replacement parts are available for purchase at [sharkaccessories.com](https://sharkaccessories.com).
2. Any unit that has been tampered with or used for commercial purposes.
3. Damage caused by misuse (e.g., vacuuming up water or other liquids), abuse, negligent handling, failure to perform required maintenance, or damage due to mishandling in transit.
4. Consequential and incidental damages.
5. Defects caused by repair persons not authorized by SharkNinja. These defects include damages caused in the process of shipping, altering, or repairing the SharkNinja product (or any of its parts) when the repair is performed by a repair person not authorized by SharkNinja.
6. Products purchased, used, or operated outside North America.

### How to get service

If your appliance fails to operate properly while in use under normal household conditions within the warranty period, visit [sharkclean.com/support](https://sharkclean.com/support) for product care and maintenance self-help. Our Customer Service Specialists are also available at **1-800-798-7398** to assist with product support and warranty service options, including the possibility of upgrading to our VIP warranty service options for select product categories. So we may better assist you, please register your product online at [registryyourshark.com](https://registryyourshark.com) and have the product on hand when you call.

SharkNinja will cover the cost for the customer to send in the unit to us for repair or replacement. A fee of \$25.95 (subject to change) will be charged when SharkNinja ships the repaired or replacement unit.

### How to initiate a warranty claim

You must call **1-800-798-7398** to initiate a warranty claim. You will need the receipt as proof of purchase. We also ask that you register your product online at [registryyourshark.com](https://registryyourshark.com) and have the product on hand when you call, so we may better assist you. A Customer Service Specialist will provide you with return and packing instruction information.

### How state law applies

This warranty gives you specific legal rights, and you also may have other rights that vary from state to state. Some states do not permit the exclusion or limitation of incidental or consequential damages, so the above may not apply to you.

## ONE (1) YEAR LIMITED BATTERY WARRANTY

The One (1) Year Limited Warranty applies to purchases made from authorized retailers of **SharkNinja Operating LLC**. Warranty coverage applies to the original owner and to the original product only and is not transferable.

SharkNinja warrants that the unit shall be free from defects in material and workmanship for a period of one (1) year from the date of purchase when it is used under normal household conditions and maintained according to the requirements outlined in the Owner's Guide, subject to the following conditions and exclusions:

### What is covered by this warranty?

1. The original battery deemed defective, in SharkNinja's sole discretion, will be replaced up to one (1) year from the original purchase date.
2. In the event a replacement battery is issued, the warranty coverage ends six (6) months following the receipt date of the replacement battery or the remainder of the existing warranty, whichever is later. SharkNinja reserves the right to replace the unit with one of equal or greater value.

### What is not covered by this warranty?

1. Normal wear and tear of the battery, which requires optimal temperature storage and operation to ensure its proper functioning.
2. A battery that has been tampered with or used for commercial purposes.
3. Damage caused by misuse (e.g., exposing battery to liquids or extreme hot and/or cold temperatures), abuse, negligent handling, failure to perform required maintenance, or damage due to mishandling in transit.
4. Consequential and incidental damages.
5. Defects caused by repair persons not authorized by SharkNinja. These defects include damages caused in the process of shipping, altering, or repairing the SharkNinja product (or any of its parts) when the repair is performed by a repair person not authorized by SharkNinja.
6. Products purchased, used, or operated outside North America.

### How to get service

If your battery fails to operate properly while in use under normal household conditions within the warranty period, visit [sharkclean.com/support](https://sharkclean.com/support) for product care and maintenance self-help. Our Customer Service Specialists are also available at **1-800-798-7398** to assist with product support and warranty service options. So we may better assist you, please register your product online at [registryyourshark.com](https://registryyourshark.com) and have the product on hand when you call.

SharkNinja will cover the cost for the customer to send in the unit to us for replacement. A fee of \$20.95 (subject to change) will be charged when SharkNinja ships the replacement unit.

### How to initiate a warranty claim

You must call **1-800-798-7398** to initiate a warranty claim. You will need the receipt as proof of purchase. We also ask that you register your product online at [registryyourshark.com](https://registryyourshark.com) and have the product on hand when you call, so we may better assist you. A Customer Service Specialist will provide you with return and packing instruction information when you call. A Customer Service Specialist will provide you with return and packing instruction information.

### How state law applies

This warranty gives you specific legal rights, and you also may have other rights that vary from state to state. Some states do not permit the exclusion or limitation of incidental or consequential damages, so the above may not apply to you.

## REGISTER YOUR PURCHASE

 registeryourshark.com

## RECORD THIS INFORMATION

Model Number: \_\_\_\_\_

Date Code: \_\_\_\_\_

Date of Purchase: \_\_\_\_\_  
(Keep receipt)

Store of Purchase: \_\_\_\_\_

**TIP:** The model and serial numbers are on the QR code label on the back of the main body.

## TECHNICAL SPECIFICATIONS

Voltage: 10.8V 

Watts: 85W

**PLEASE READ CAREFULLY AND KEEP FOR FUTURE REFERENCE.**

This Owner's Guide is designed to help you keep your VACMOP™ running at peak performance.

**BATTERY REMOVAL AND DISPOSAL**

**This product uses a lithium-ion rechargeable and recyclable battery. When the battery no longer holds a charge, it should be removed from the VACMOP and recycled. DO NOT incinerate or compost the battery.**

When your lithium-ion battery needs to be replaced, dispose of it or recycle it in accordance with local ordinances or regulations. In some areas, it is illegal to place spent lithium-ion batteries in the trash or in a municipal solid waste stream. Return spent battery to an authorized recycling center or to retailer for recycling. Contact your local recycling center for information on where to drop off the spent battery.

The RBRC™ (Rechargeable Battery Recycling Corporation) seal on the lithium-ion battery indicates that the costs to recycle the battery at the end of its useful life have already been paid by SharkNinja. In some areas, it is illegal to place spent lithium-ion batteries in the trash or municipal solid waste stream and the RBRC program provides an environmentally conscious alternative.

RBRC, in cooperation with SharkNinja and other battery users, has established programs in the United States and Canada to facilitate the collection of spent lithium-ion batteries. Help protect our environment and conserve natural resources by returning the spent lithium-ion battery to an authorized SharkNinja service center or to your local retailer for recycling. You may also contact your local recycling center for information on where to drop off the spent battery, or call 1-800-798-7398.



**Note:**

This equipment has been tested and found to comply with the limits for a Class B digital device, pursuant to part 15 of the FCC Rules. These limits are designed to provide reasonable protection against harmful interference in a residential installation. This equipment generates, uses and can radiate radio frequency energy and, if not installed and used in accordance with the instructions, may cause harmful interference to radio communications. However, there is no guarantee that interference will not occur in a particular installation. If this equipment does cause harmful interference to radio or television reception, which can be determined by turning the equipment off and on, the user is encouraged to try to correct the interference by one or more of the following measures:

- Reorient or relocate the receiving antenna.
- Increase the separation between the equipment and receiver.
- Connect the equipment into an outlet on a circuit different from that to which the receiver is connected.
- Consult the dealer or an experienced radio/TV technician for help.

This device complies with Part 15 of the FCC Rules. Operation is subject to the following two conditions:

1. This device may not cause harmful interference, and
2. This device must accept any interference received, including interference that may cause undesired operation.

**Caution: Any changes or modifications to this unit not expressly approved by the party responsible for compliance could void the user's authority to operate the equipment.**



**PLEASE READ CAREFULLY AND KEEP FOR FUTURE REFERENCE.**

This Owner's Guide is designed to help you get a complete understanding of your new Shark® VACMOP™ cordless hard floor system.

SharkNinja Operating LLC  
US: Needham, MA 02494  
CAN: Ville St-Laurent, QC H4S 1A7  
1-800-798-7398  
sharkclean.com

Illustrations may differ from actual product. We are constantly striving to improve our products, therefore the specifications contained herein are subject to change without notice.

This product may be covered by one or more U.S. patents. See [sharkninja.com/patents](http://sharkninja.com/patents) for more information.