

Shark FREESTYLE CORDLESS VACUUM

SV1100 Series

OWNER'S GUIDE

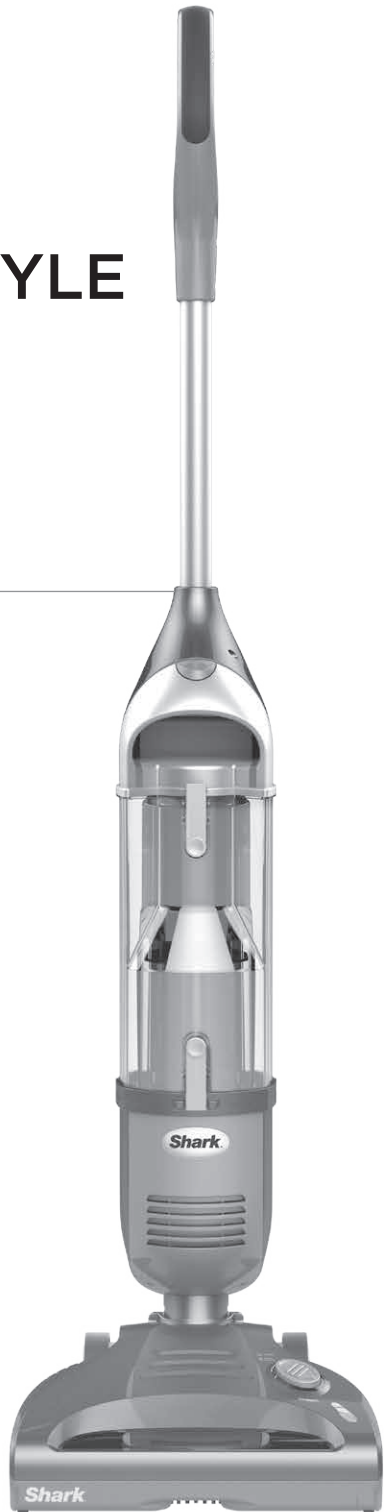

IMPORTANT SAFETY INSTRUCTIONS

FOR HOUSEHOLD USE ONLY • PLEASE READ CAREFULLY BEFORE USE

If the charger plug does not fit fully into the outlet, reverse the plug. If it still does not fit, contact a qualified electrician. **DO NOT** force into outlet or try to modify to fit.

WARNING

To reduce the risk of fire, electric shock, injury, or property damage:

THE FLOOR NOZZLE, WAND, POD, AND HANDLE CONTAIN ELECTRICAL CONNECTIONS:

1. This vacuum consists of a motorized nozzle, wand, vacuum pod, handle, and hose. These components contain electrical connections, electrical wiring, and moving parts that potentially present risk to the user.
2. Before each use, carefully inspect all parts for any damage. If a part is damaged, discontinue use.
3. Use only identical replacement parts.
4. This vacuum contains no serviceable parts.
5. Use only as described in this manual. **DO NOT** use the vacuum for any purpose other than those described in this manual.
6. With the exception of filters, **DO NOT** expose any parts of the vacuum to water or other liquids.

GENERAL USE

7. This vacuum is not intended for use by anyone with reduced physical, sensory or mental capabilities, or lack of experience and knowledge, unless they have been given supervision or instruction concerning use of the appliance by a person responsible for their safety. Children should be supervised to ensure that they **DO NOT** play with the vacuum.
8. Always turn off the vacuum before connecting or disconnecting any current carrying hoses, motorized nozzles, chargers, batteries, or other electrical or mechanical parts.
9. **DO NOT** handle plug or vacuum with wet hands.
10. **DO NOT** use without dust cup, filters, and brushrolls in place.

11. Only use Shark® branded filters and accessories. Failure to do so will void the warranty.
12. **DO NOT** put any objects into nozzle or accessory openings. **DO NOT** use with any opening blocked; keep free of dust, lint, hair, and anything that may reduce airflow.
13. **DO NOT** use if nozzle or accessory airflow is restricted. If the air paths or the motorized floor nozzle become blocked, turn the vacuum off and remove the battery. Remove all obstructions before you reinsert the battery and turn on the unit again.
14. Keep nozzle and all vacuum openings away from hair, face, fingers, uncovered feet, or loose clothing.
15. **DO NOT** use if vacuum is not working as it should, or has been dropped, damaged, left outdoors, or dropped into water.
16. Use extra care when cleaning on stairs.
17. **DO NOT** leave the vacuum unattended while powered on.
18. When powered on, keep the vacuum moving over the carpet surface at all times to avoid damaging the carpet fibers.
19. **DO NOT** place vacuum on unstable surfaces such as chairs or tables.
20. **DO NOT** use to pick up:
 - a) Liquids
 - b) Large objects
 - c) Hard or sharp objects (glass, nails, screws, or coins)
 - d) Large quantities of dust (including drywall, fireplace ash, or embers). **DO NOT** use as an attachment to power tools for dust collection.
 - e) Smoking or burning objects (hot coals, cigarette butts, or matches)
 - f) Flammable or combustible materials (lighter fluid, gasoline, or kerosene)
 - g) Toxic materials (chlorine bleach, ammonia, or drain cleaner)
21. **DO NOT** use in the following areas:
 - a) Poorly lit areas
 - b) Wet or damp surfaces
 - c) Outdoor areas
 - d) Spaces that are enclosed and may contain explosive or toxic fumes or vapors (lighter fluid, gasoline, kerosene, paint, paint thinners, mothproofing substances, or flammable dust)
22. Turn off the vacuum before servicing the battery, as well as before plugging in or unplugging the charger.
23. Turn off the vacuum before any adjustment, cleaning, maintenance, or troubleshooting. Such preventative safety measures reduce the risk of starting the appliance accidentally.
24. During cleaning or routine maintenance, **DO NOT** cut anything other than hair, fibers, or string wrapped around the brushroll.
25. Allow all filters to air-dry completely before replacing in the vacuum to prevent liquid from being drawn into electric parts.
26. **DO NOT** modify or attempt to repair the vacuum or the battery yourself, except as indicated in this manual. **DO NOT** use the battery or vacuum if it has been modified or damaged. Damaged or modified batteries may exhibit unpredictable behavior resulting in fire, explosion, or risk of injury.

BATTERY PACK

27. The battery is the power source for the vacuum. Carefully read and follow all charging instructions.
28. To prevent unintentional starting, ensure the vacuum is powered off before picking up or carrying the vacuum. **DO NOT** carry the appliance with your finger on the power switch.
29. Use Charger XA1106N for 10.8V unit and Charger XA1106 FOR 14.4V unit
30. Keep the battery away from all metal objects such as paper clips, coins, keys, nails, or screws. Shorting the battery terminals increases the risk of fire or burns.
31. Under abusive conditions, liquid may be ejected from the battery. Avoid contact with this liquid, as it may cause irritation or burns. If contact occurs, flush with water. If liquid contacts eyes, seek medical help.
32. Battery should not be stored at temperatures below 37.4°F (3°C) or above 104°F (40°C) to maintain long-term battery life.
33. **DO NOT** charge battery at temperatures below 50°F (10°C) or above 104°F (40°C).
34. Store the appliance indoors. **DO NOT** use or store it below 37.4°F (3°C). Ensure the appliance is at room temperature before operating.
35. **DO NOT** expose the battery to fire or temperatures above 265°F (130°C) as it may cause explosion.
36. Follow all charging instructions. **DO NOT** charge the battery at temperatures below 50°F (10°C) or above 104°F (40°C). Charging improperly or at temperatures not in the specified range may damage the battery and increase the risk of fire.

SAVE THESE INSTRUCTIONS

GETTING TO KNOW YOUR SHARK® FREESTYLE CORDLESS VACUUM

WELCOME!

Congratulations on your purchase. Use this instruction manual to learn about your new vacuum's great features. From assembly to use to maintenance, you will find it all in here.

MAIN UNIT

- A** Handle
- B** Main Body
- C** Screw
- D** Dust Cup Release
- E** Upper Dust Cup Latch
- F** Dust Cup
- G** Lower Dust Cup Latch
- H** Motorized Floor Nozzle
- I** Power Button/Surface Selector
- J** Charging Adapter
- K** Precision Charger Base

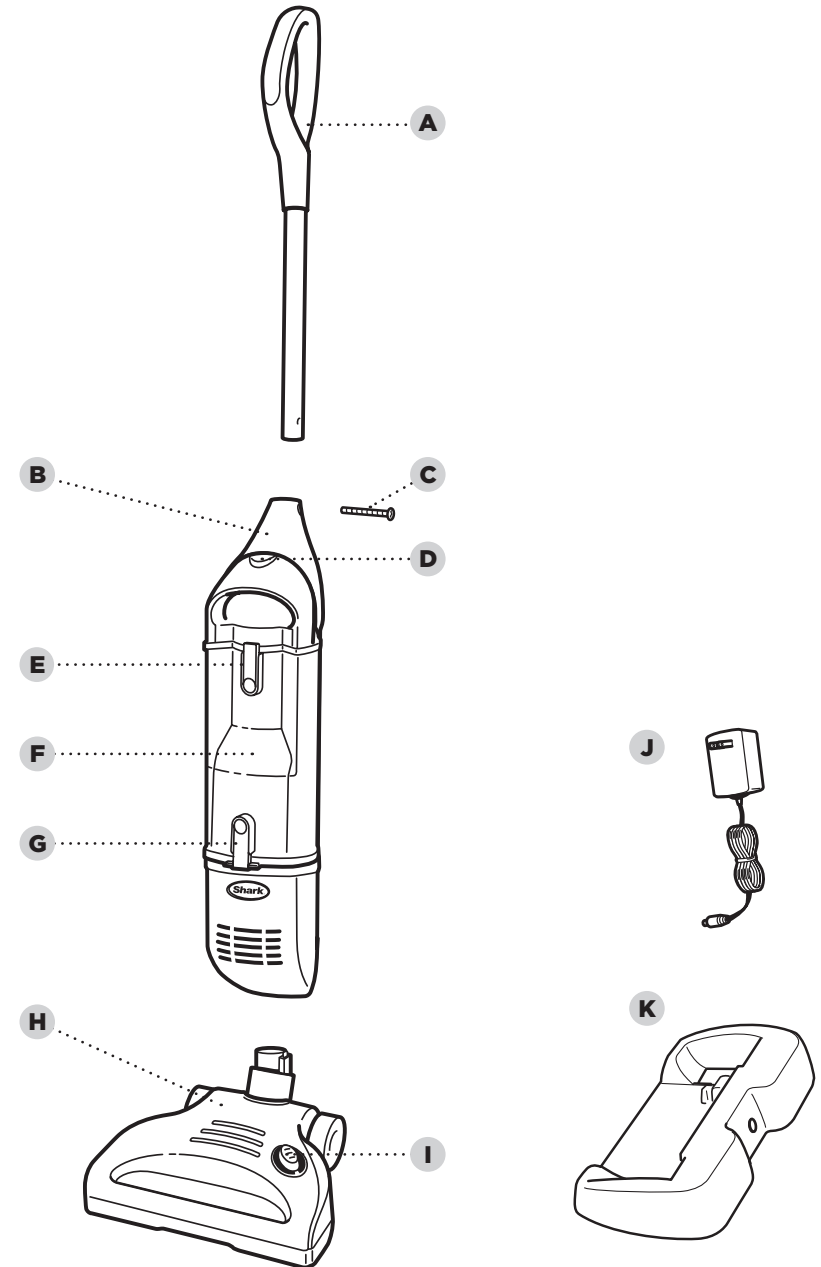

ASSEMBLING YOUR VACUUM

 **TIP:** Before using vacuum, ensure the dust cup is securely in place.

 **TIP:** Charge the vacuum fully before first use. Depending on usage, the time to reach a full charge is approximately between 4 to 7 hours.

.....

HOW DO I KNOW WHEN THE VACUUM IS CHARGED?

The entire oval blue light around the power button flashes.

The unit is still charging.

One half of the oval blue light around the power button flashes.

The unit is fully charged.

STEP 1

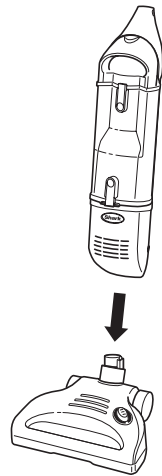

- 1** Insert vacuum body into floor nozzle.

STEP 2

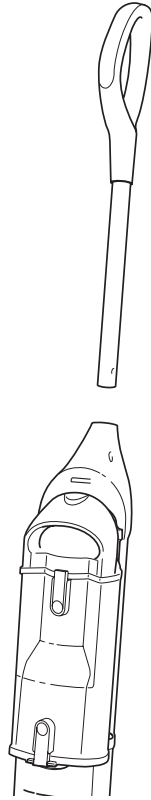

- 2** Insert handle pole into main body and secure by screwing in bolt (taped to handle during shipping).

STEP 3

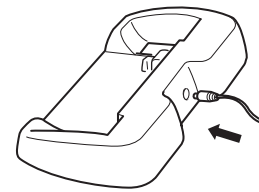

- 3** Insert the charging adapter plug by aligning the arrows on the plug and charging jack. Push in until it clicks into place.

STEP 4

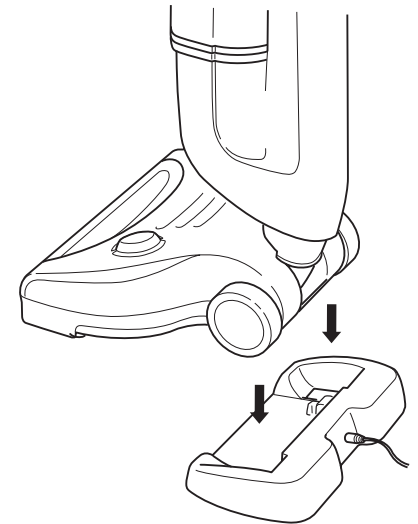

- 4** Place vacuum on precision charger base.

USING YOUR VACUUM

TIP: The oval blue light around the power button will indicate which setting you are on.

On the high speed carpet setting, the vacuum will run for approximately 12 minutes.

On the lower speed bare floor setting, the vacuum will run for approximately 17 minutes.

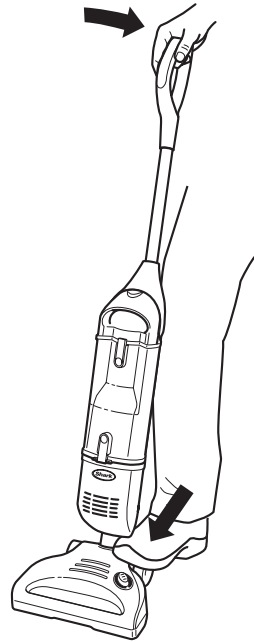

1 Place foot on floor nozzle and tilt handle back.

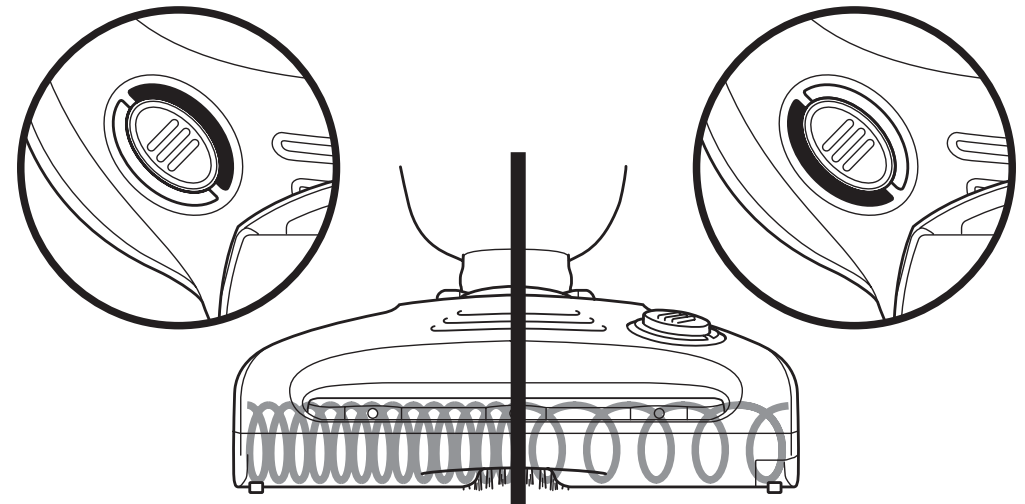

2 Press the power button once to turn on the carpet setting. The brushroll will spin quickly in this mode to get

deep carpet cleaning.

3 Press the power button a second time to turn on the bare floor setting. The brushroll will spin slowly in this setting to vacuum up all of the surface litter on carpet and bare floors.

Press the power button a third time to turn off the vacuum.

MAINTENANCE

To keep your vacuum's suction power optimal, follow these instructions. Turn off the power and remove the unit from the charger base.

⚠ WARNING: DO NOT operate the vacuum with a wet filter.

DO NOT use a hair dryer or other forced hot air to dry the filter.

DO NOT operate vacuum without the filter in place.

RECOMMENDED CLEANING SCHEDULE:

Dust Cup

Empty dust cup after every use or as debris approaches the MAX FILL line.

If the dust cup door does not swing open after pressing the release button, press down on the tabs on either side of the button to release the door.

Foam Filter

XF1100T
Clean the foam filter once per month.

STEP 1

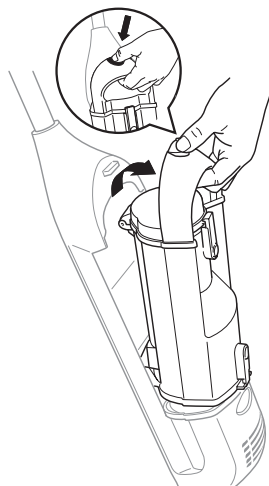

STEP 2

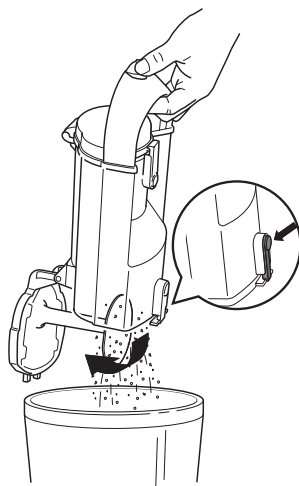

STEP 3

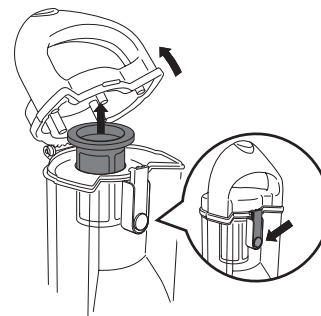

STEP 1

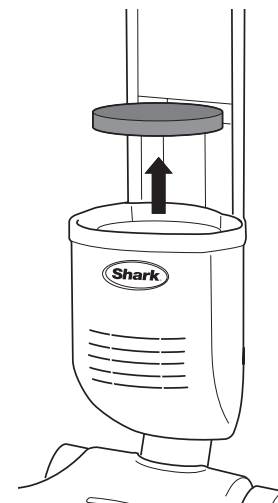

STEP 2



EMPTYING THE DUST CUP

- 1 Press down on the dust-cup release button and lift dust cup out.
- 2 Hold dust cup over a trash bin and press

- 3 Press the top dust-cup release latch and pull

up on handle. Lift out metal screen and clear debris.

CLEANING THE FILTER

- 1 Remove the dust cup, then remove the foam filter.
- 2 Hand wash filter with water only. Squeeze excess water out and allow filter to air-dry completely before returning filter to the unit.

MAINTENANCE

 **TIP:** The brushroll is equipped with a raised cutting guide to easily cut hair and debris.

STEP 1

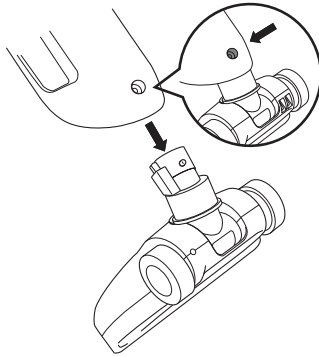

BLOCKAGES IN NOZZLE

- 1 Press the release button on the rear of the main body and remove the floor

STEP 2

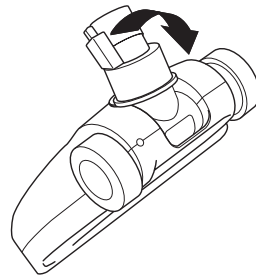

nozzle.

STEP 3

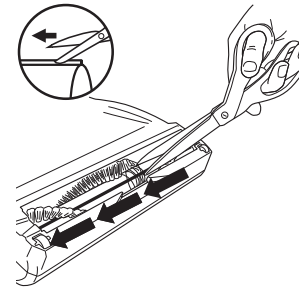

- 2 Pull back the neck of the floor nozzle to straighten the air passage and remove debris.

STEP 4

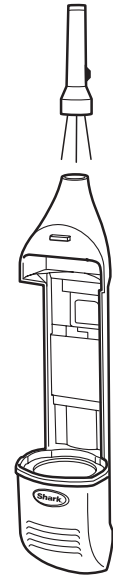

CLEANING THE BRUSHROLL

- 3 Flip the nozzle over to access brushroll. Use scissors to carefully remove hair and debris wrapped around the brushroll.

BLOCKAGES IN MAIN UNIT

- 4 You can also check for blockages in the main body. Just remove floor nozzle and dust cup and shine a flashlight in the opening.

BRUSHROLL REMOVAL AND INSERTION

STEP 1

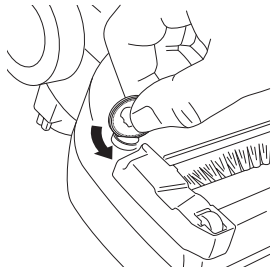

1 Use the edge of a coin to turn the dial near the brushroll access door to the unlocked position.

STEP 2

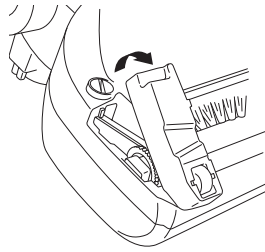

2 Remove brushroll access door.

STEP 3

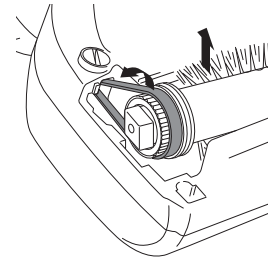

3 Slip black belt off of white gear and lift out brushroll to clean off debris.

STEP 4

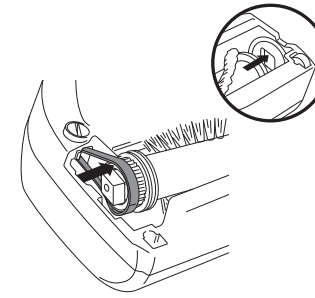

4 Once the brushroll has been cleaned, reinsert by slipping the black belt back onto the white gear.

STEP 5

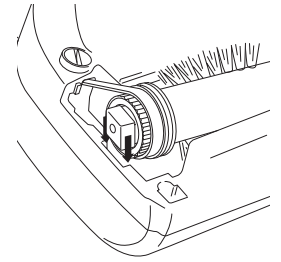

5 Align the white square at the end of the brushroll with the slot near the belt. Fit the square into the slot.

BATTERY PACK REPLACEMENT & DISPOSAL

⚠ WARNING: This unit is powered by Ni-Mh batteries, which must be recycled or disposed of properly in accordance with state, federal and local laws.

If uncertain how to remove the battery pack, we suggest you take your vacuum to a reputable small appliance service technician to have this service performed.

⚠ WARNING: Never use ordinary batteries for replacement as these may leak and damage your vacuum. Use only the battery pack provided by SharkNinja for replacement.

⚠ WARNING: Do not store or charge in areas of high temperature or humidity.

Replacement Battery Part Number

10.8V XBT1106N :
SV1110, SV1106N

14.4V XBT1106 :
SV1112, SV1114, SV1115

Charging Adapter Part Number

10.8V XA1106N :
SV1110, SV1106N

14.4V XA1106 : SV1112,
SV1114, SV1115

MAXIMIZING THE LIFE OF YOUR BATTERY

- 1 This vacuum is equipped with an advanced feature that will shut off the vacuum when the battery is almost fully discharged. If the vacuum shuts off while in use, charge the unit until one half of the oval blue light around the power button flashes, indicating a full charge.
- 2 Charge the vacuum for 7 hours before initial use. After initial use, each recharge will take approximately 4 to 7 hours because the charger monitors battery properties to extend battery life. The entire oval LED light around the power button will flash every 2 seconds while the unit is charging. When the charge is complete, one half of the oval will flash every 2 seconds.
- 3 The precision charger monitors the batteries so you don't have to. Leaving the unit charging past the complete charge time will NOT harm the batteries.
- 4 If the vacuum has never been used or has not been used for an extended period of time, it will take 3 to 5 complete charge and run-down cycles to realize the full operational time of the vacuum.
- 5 Use only the charger adapter supplied with the unit : XA1106N for SV1106N, SV1110 (10.8 V) and XA1106 for SV1112, SV1114 and SV1115 (14.4V). If other chargers are used, the battery can fail, causing damage to the battery, to the vacuum, or to personal property.

STEP 1

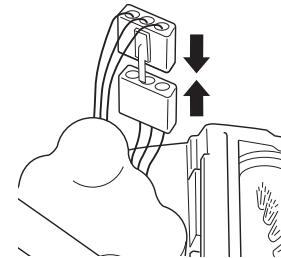

- 1 Push the connector terminals together until they lock into place.

STEP 2

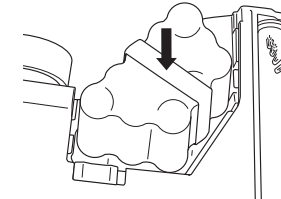

- 2 Place the new battery pack into the battery compartment, taking care to tuck the wiring completely so that it does not interfere with the battery access door.

STEP 3

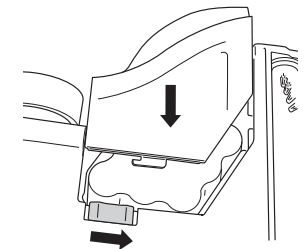

- 3 Place the battery door onto the bottom of the nozzle, slide it back into place and move the sliding tab next to the door to the lock position.

TROUBLESHOOTING GUIDE

⚠ WARNING: To reduce the risk of shock and unintended operation, turn power off and unplug unit before servicing.

Vacuum is not picking up debris. No suction or light suction.

(Refer to Maintenance section for more information.)

- Check filters to see if they need cleaning. Follow instructions for rinsing and drying the filters before re-inserting in the vacuum.
- Dust cup may be full; empty dust cup.
- Remove any string, carpet fibers, or hair that may be wrapped around the brushroll.
- Check for blockages in the dust cup filter and floor nozzle.
- Make sure that the battery is fully charged.

Vacuum will not operate.

- The battery may be depleted. Charge the vacuum until half of the oval light flashes, indicating full charge.
- The brushroll may be jammed. Turn the unit off and allow it to cool down for 10 seconds.
- Ensure nothing is blocking the motorized brush or wrapped around the brushroll.

Charging indicator does not illuminate.

- Check to see if the charge adapter is plugged in properly to the outlet and to the charging jack.
- Ensure there is no debris accumulated on the metal charge contacts on the floor nozzle or charging adaptor.
- Ensure that the electrical outlet is supplying power to the charger.

Motorized brush will not work.

- The floor nozzle may have blockage; See “Clearing Blockages”.
- Ensure that the floor nozzle is properly attached.

Dust escapes from vacuum.

- Empty the dust cup container.
- Ensure that the filter is inserted completely into its holder below the dust cup.
- Check for punctures in dust cup filter or cracks in the dust cup and replace if necessary.

Vacuum turns off on its own.

- Charge the unit until half of the oval flashes, indicating a full charge.

Run Time has decreased over time.

If you experience shorter run time over the life of the vacuum, perform the following battery reconditioning steps. These steps can also be performed as monthly maintenance for maximum battery life.

- Make sure the vacuum is fully charged (this could take up to 7 hours).
- Run vacuum until it turns itself off.
- Fully charge the vacuum again.

Shark | NINJA

ONE (1) YEAR LIMITED WARRANTY

The One (1) Year Limited Warranty applies to purchases made from authorized retailers of **SharkNinja Operating LLC**. Warranty coverage applies to the original owner and to the original product only and is not transferable.

SharkNinja warrants that the unit shall be free from defects in material and workmanship for a period of one (1) year from the date of purchase when it is used under normal household conditions and maintained according to the requirements outlined in the Owner's Guide, subject to the following conditions and exclusions:

What is covered by this warranty?

1. The original unit and/or non-wearable parts deemed defective, in SharkNinja's sole discretion, will be repaired or replaced up to one (1) year from the original purchase date.
2. In the event a replacement unit is issued, the warranty coverage ends six (6) months following the receipt date of the replacement unit or the remainder of the existing warranty, whichever is later. SharkNinja reserves the right to replace the unit with one of equal or greater value.

What is not covered by this warranty?

1. Normal wear and tear of wearable parts (such as foam filters, HEPA filters, pads, etc.), which require regular maintenance and/or replacement to ensure the proper functioning of your unit, are not covered by this warranty. Replacement parts are available for purchase at sharkaccessories.com.
2. Any unit that has been tampered with or used for commercial purposes.
3. Damage caused by misuse (e.g., vacuuming up water or other liquids), abuse, negligent handling, failure to perform required maintenance (e.g., not cleaning the filters, not removing debris from the brushroll), or damage due to mishandling in transit.
4. Consequential and incidental damages.
5. Defects caused by repair persons not authorized by SharkNinja. These defects include damages caused in the process of shipping, altering, or repairing the SharkNinja product (or any of its parts) when the repair is performed by a repair person not authorized by SharkNinja.
6. Products purchased, used, or operated outside North America.

How to get service

If your appliance fails to operate properly while in use under normal household conditions within the warranty period, visit sharkclean.com/support for product care and maintenance self-help. Our Customer Service Specialists are also available at **1-800-798-7398** to assist with product support and warranty service options, including the possibility of upgrading to our VIP warranty service options for select product categories. So we may better assist you, please register your product online at registryyourshark.com and have the product on hand when you call.

SharkNinja will cover the cost for the customer to send in the unit to us for repair or replacement. A fee of \$25.95 (subject to change) will be charged when SharkNinja ships the repaired or replacement unit.

How to initiate a warranty claim

You must call **1-800-798-7398** to initiate a warranty claim. You will need the receipt as proof of purchase. We also ask that you register your product online at registryyourshark.com and have the product on hand when you call, so we may better assist you. A Customer Service Specialist will provide you with return and packing instruction information.

How state law applies

This warranty gives you specific legal rights, and you also may have other rights that vary from state to state. Some states do not permit the exclusion or limitation of incidental or consequential damages, so the above may not apply to you.



FCC WARNINGS

This equipment has been tested and found to comply with the limits for a Class B digital device, pursuant to parts 15 of the FCC Rules. These limits are designed to provide reasonable protection against harmful interference in a residential installation. This equipment generates, uses, and can radiate radio frequency energy and, if not installed and accordance with the instructions, may cause harmful interference to radio communications. However, there is no guarantee that interference will not occur in a particular installation. If this equipment does cause harmful interference to radio or television reception, which can be determined by turning the equipment off and on, the user is encouraged to try to correct the interference by one or more of the following measures:

- 1 Reorient or relocate the receiving antenna.
- 2 Increase the separation between the equipment and receiver.
- 3 Connect the equipment into an outlet on a circuit different from that to which the receiver is connected.
- 4 Consult the dealer or an experienced radio/TV technician for help.

This Device complies with part 15 of the FCC rules. Operation is subject to the following conditions:

- 1 This device may not cause harmful interference
- 2 This device must accept any interference received, including interference that may cause undesired operation.

Changes or modifications not expressly approved by the party responsible for compliance could void the user's authority to operate this device.



BATTERY REMOVAL AND DISPOSAL

This product uses a battery. When the battery no longer holds a charge, it should be removed from the vacuum and recycled. **DO NOT** incinerate or compost the battery.

When your lithium-ion battery needs to be replaced, dispose of it or recycle it in accordance with local ordinances or regulations. In some areas, it is illegal to place spent lithium-ion batteries in the trash or in a municipal solid waste stream. Return spent battery to an authorized recycling center or to retailer for recycling. Contact your local recycling center for information on where to drop off the spent battery.

For more information on battery removal for disposal, please visit sharkclean.com/batterysupport.

The RBRC™ (Rechargeable Battery Recycling Corporation) seal on the lithium-ion battery indicates that the costs to recycle the battery at the end of its useful life have already been paid by SharkNinja. In some areas, it is illegal to place spent lithium-ion batteries in the trash or municipal solid waste stream and the RBRC program provides an environmentally conscious alternative.

RBRC, in cooperation with SharkNinja and other battery users, has established programs in the United States and Canada to facilitate the collection of spent lithium-ion batteries. Help protect our environment and conserve natural resources by returning the spent lithium-ion battery to an authorized SharkNinja service center or to your local retailer for recycling. You may also contact your local recycling center for information on where to drop off the spent battery, or call 1-800-798-7398.

SharkNinja Operating LLC
 US: Needham, MA 02494
 CAN: Ville St-Laurent, QC H4S 1A7
 1-888-228-5531
sharkclean.com

Illustrations may differ from actual product. We are constantly striving to improve our products; therefore the specifications contained herein are subject to change without notice.

SHARK is a registered trademark of SharkNinja Operating LLC.

This product may be covered by one or more U.S. patents.

See sharkninja.com/patents for more information.



@sharkcleaning