

2 WAYS TO CLEAN

UPRIGHT

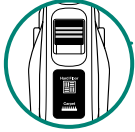

Floor Setting

Slide the Floor Selector up or down to choose floor type.

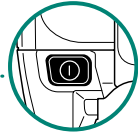
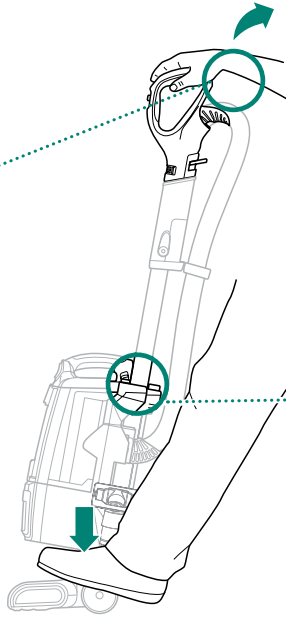

Power

Push the Power button to turn the vacuum on or off.

LIFT-AWAY®

Suction Control

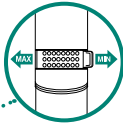

Lift-Away Release

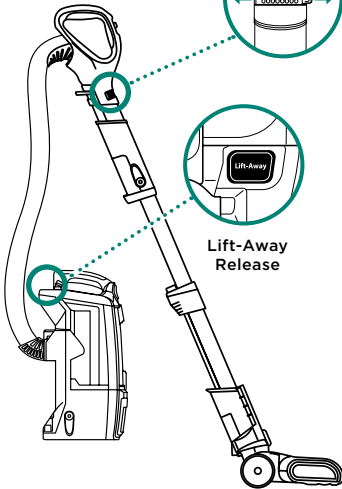

Handle Release

OR



Wand Release

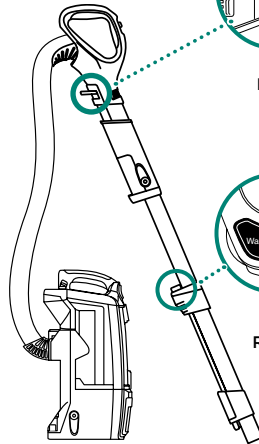

Attach accessories to handle or wand.

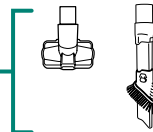

For questions or to register your product, contact us at 1-800-798-7398 or visit us online at sharkclean.com



@sharkcleaning