

VERSATILE CLEANING

FLOOR

Press the Power button, then choose your Surface setting and your Suction setting. Place your foot gently on the floor nozzle and tilt the handle back.

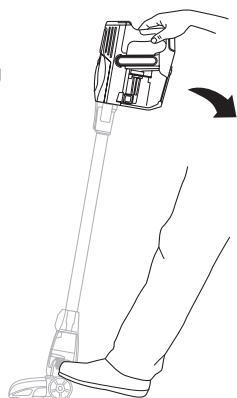

NOTE: Brushroll will only engage when the handle is tilted back.

ABOVE-FLOOR

Stand the vacuum upright. Step on the Floor Nozzle Release button and pull the wand up to disconnect it from the motorized floor nozzle.

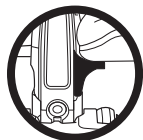

Floor Nozzle Release

OR

Press the Wand Release button on the top of the wand to disconnect it from the handheld vacuum.



Wand Release

Attach desired cleaning accessory, then choose your Suction setting.

Please make sure to read the enclosed Shark® Owner's Guide prior to using your vacuum.

Shark ION™ X30

CORD-FREE ULTRA-LIGHT



CONVENIENT STORAGE

Release the handvac and hook onto wand for convenient storage in small spaces.

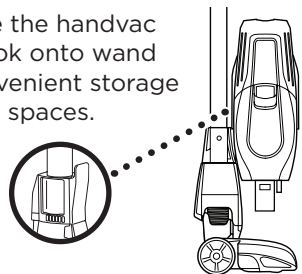

Wall Mount and additional charging options available at sharkaccessories.com.

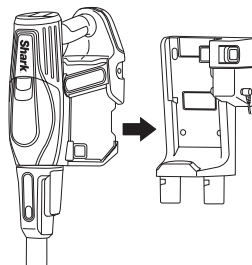

EMPTYING THE DUST CUP

1. To empty dust cup, first remove the handvac from the wand by pressing the Wand Release button and pulling up on the handvac.

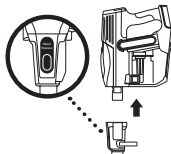

2. Position dust cup over a trash bin, then open the bottom of the dust cup by pressing the Dust Cup Release button on the side.

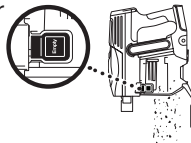

QUICK START GUIDE

Use this Quick Start Guide to start using your new vacuum's great features.

For questions, visit us online at sharkclean.com

Register your vacuum at registeryourshark.com

Shark



@sharkcleaning

©2018 SharkNinja Operating LLC. SHARK is a registered trademark of SharkNinja Operating LLC. SHARK ION and SMART RESPONSE are trademarks of SharkNinja Operating LLC.

IR100_QSG_REV_MP_180621

IR100

WHAT'S INSIDE:

- A** Handheld Vacuum
- B** Motorized Floor Nozzle
- C** Wand
- D** Onboard Storage Hook
- E** 8" Crevice Tool
- F** ION Power Pack
- G** ION Power Pack Charger

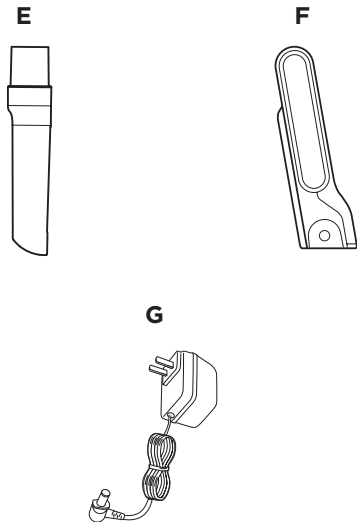

ASSEMBLY

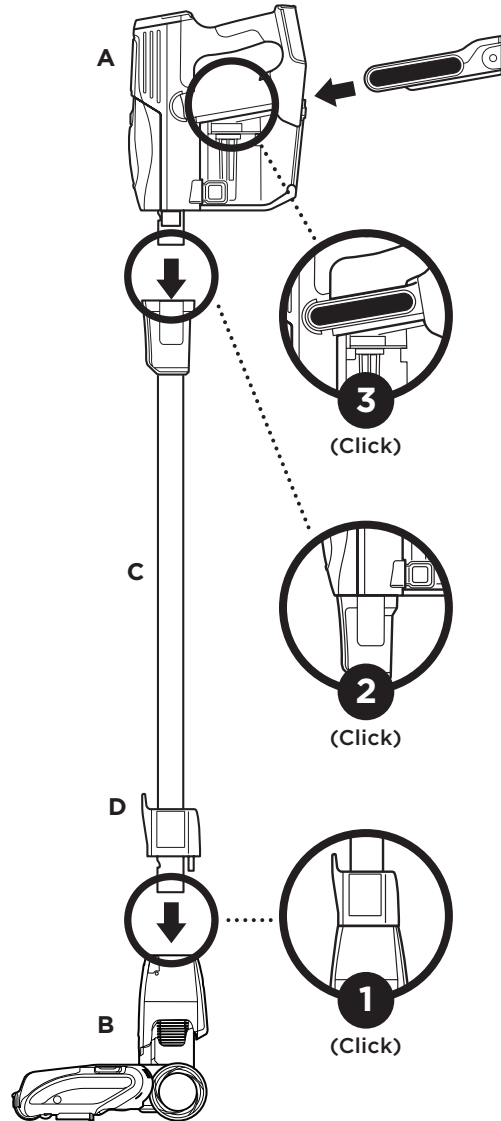

SMART RESPONSE™ TECHNOLOGY

Press the Surface Settings button to switch floor types. Press the ION BOOST button to intelligently switch between ION POWER AND ION BOOST.

Surface Settings



CARPET

For carpets.



FLOOR

For bare floors and small area rugs.

Power Button

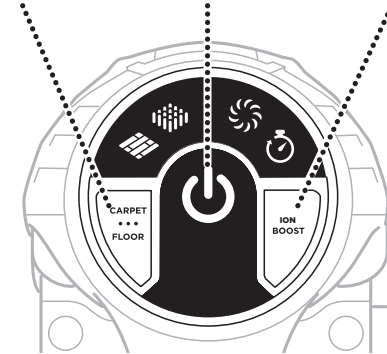

Suction Settings



ION POWER

For everyday cleaning.



ION BOOST

Press for a timed 1-minute boost of increased suction for high-traffic areas and heavy messes. Press and hold for manual control of ION Boost for as long as you need it.

NOTE: For deep cleaning per ASTM F 608 (embedded dirt in carpets) please select CARPET and ION BOOST settings.
NOTE: Select Carpet setting for stuck-on dirt and debris.

ION POWER PACK

In Use



Charging



NOTE: Full charge takes approximately 3.5 hours.

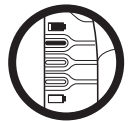

Battery Indicator Lights

NOTE: ION Power Pack comes with a partial charge. Fully charge prior to first use and then completely discharge to condition the pack.

VERSATILE CHARGING

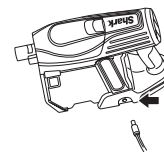

IN THE VACUUM

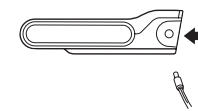

OUT OF THE VACUUM

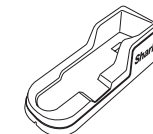

IN AVAILABLE CHARGING DOCK

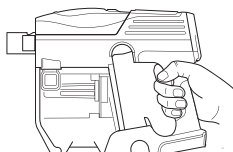

Easily Insert or Remove the ION Power Pack

To insert, slide the ION Power Pack into the slot in the back of the hand vac.

To remove, pinch the release tab then slide out the ION Power Pack.

For complete maintenance instructions, see the enclosed Owner's Guide.

For additional parts and accessories, visit sharkaccessories.com.

For additional batteries and charging accessories, visit sharkclean.com/batteries.