

VERSATILE CLEANING

Slide the power button to the desired power setting. Place your foot on the floor nozzle and tilt the handheld vacuum back.

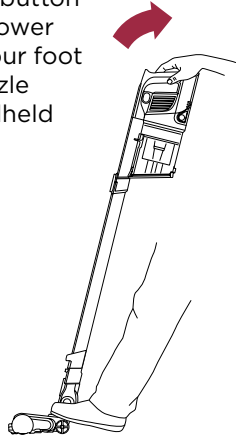

NOTE: Brushroll will only engage when the handle is tilted back.

To detach the wand for above-floor cleaning, stand the vacuum upright, then press the Nozzle Release button on the bottom of the wand and pull the wand up to disconnect it.

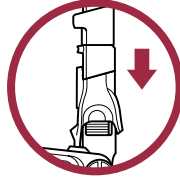

OR

To detach the handheld vacuum, press the Wand Release button and lift the handheld vacuum off the wand.

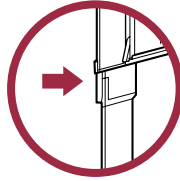

THEN

Attach a cleaning accessory, then choose the power setting.

EMPTYING THE DUST CUP

1. To empty the dust cup, first disconnect the handheld vacuum from the wand by pressing the Wand Release button and pulling up on the handheld vacuum.

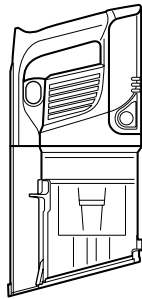

Wand Release Button



2. Position the dust cup over a trash bin and slide the CleanTouch™ Dirt Ejector forward.

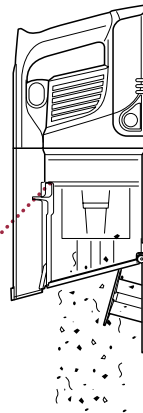

CleanTouch
Dirt Ejector

Please make sure to read the enclosed Shark® Owner's Guide prior to using your vacuum.

Shark® ROCKET® PRO

POWERFINS CORDLESS VACUUM



QUICK START GUIDE

For questions, visit us online at sharkclean.com/support

Register your vacuum at registryourshark.com

Shark



@sharkcleaning

© 2020 SharkNinja Operating LLC. ROCKET and SHARK are registered trademarks of SharkNinja Operating LLC. CLEAN TOUCH is a trademark of SharkNinja Operating LLC.

IZ362H_QSG_MP_Mv3

IZ362H

WHAT'S INSIDE:

- A Handheld Vacuum
- B PowerFins Floor Nozzle
- C Wand w/Handheld Storage Clip
- D Crevice Tool
- E Upholstery Tool
- F Charger
- G Li-Ion Battery (Pre-Installed)
- H HEPA Post-Motor Filter (Pre-Installed)

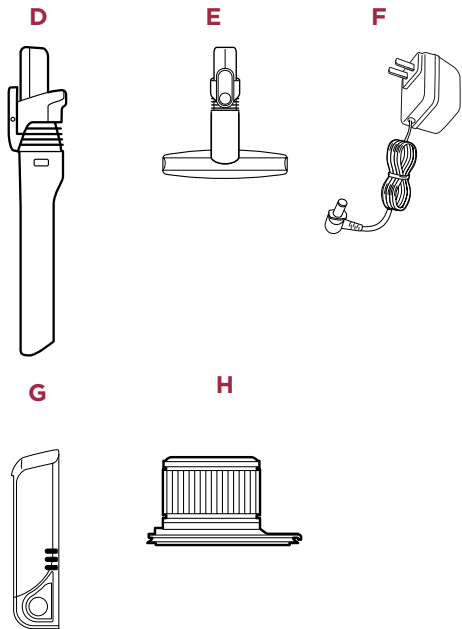

ASSEMBLY

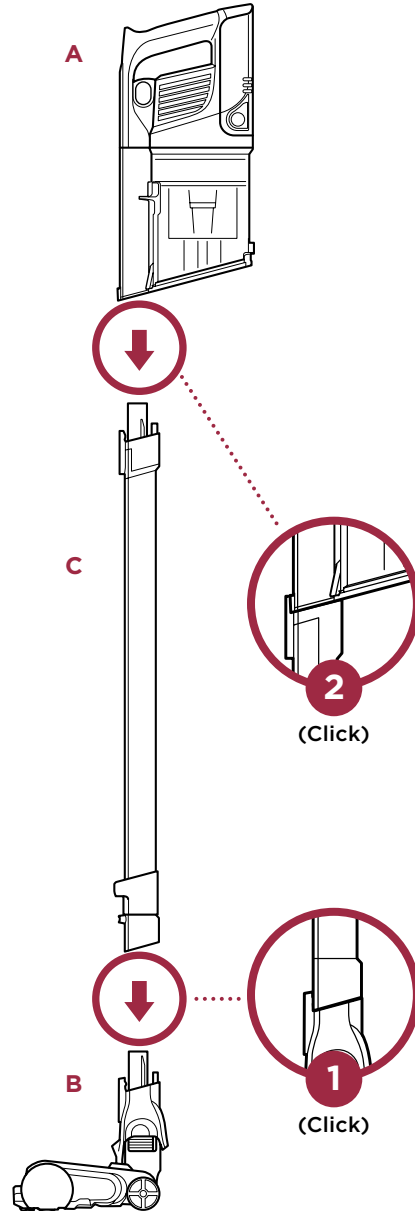

POWER SETTINGS

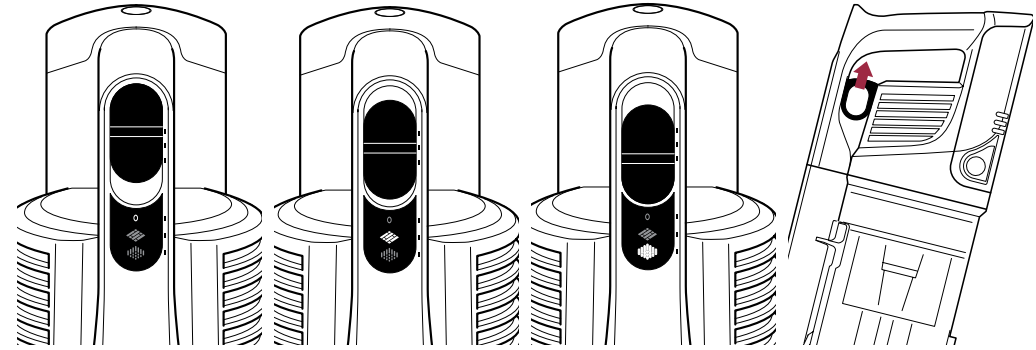

OFF

Slide switch to the top to turn off power. To begin vacuuming in **Standard Mode**, slide switch to the appropriate setting.

BARE FLOOR SETTING

Bare Floor/Area Rugs
Slide switch to the middle. The brushroll spins slowly to clean bare floors and small area rugs.

CARPET SETTING

Carpet
Slide switch to the bottom. The brushroll spins faster to pick up debris below the surface of your carpets.

BOOST MODE

For an added boost in power, pull the **Trigger** on the handheld vacuum. Release it to return to standard power.

NOTE: For deep cleaning per ASTM F 608 (embedded dirt in carpets) please select the Carpet setting and pull the trigger to go into Boost mode.

NOTE: Select Carpet setting for stuck-on dirt and debris.

CHARGING

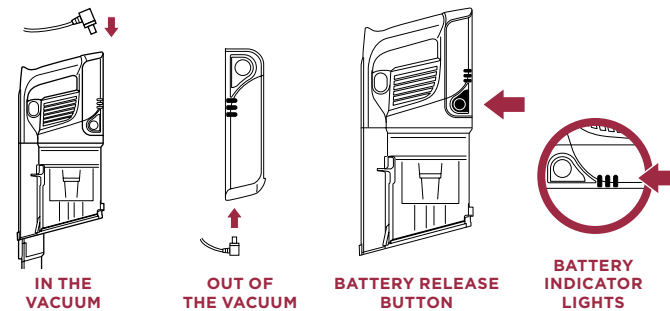

Easily Insert or Remove the Li-Ion Battery

To insert, slide the Battery into the slot in the back of the handheld vacuum. To remove, press and hold the **Battery Release Button** then slide out the battery.

LI-ION BATTERY

In Use



Charging



NOTE: Full charge takes approximately 3 hours.

NOTE: The battery comes partially charged. Charge fully before first use.

Battery Runtime

MODE	MINUTES
Hand Vac	40
Bare Floor/ Standard Mode	25
Carpet Mode/ Standard Mode	20
Boost Mode (Hand Vac)	10

For complete maintenance instructions, see the enclosed Owner's Guide.

For additional parts and accessories, visit sharkaccessories.com.

For additional batteries and charging accessories, visit sharkclean.com/batteries.