

Shark®

**Lift-Away
Garment Pro**

fabric steamer

User's Guide

GS400



www.sharkclean.com

IMPORTANT SAFETY INSTRUCTIONS

For Household Use Only

WHEN USING YOUR SHARK® LIFT-AWAY GARMENT PRO FABRIC STEAMER, BASIC SAFETY PRECAUTIONS SHOULD ALWAYS BE FOLLOWED, INCLUDING THE FOLLOWING:

READ ALL INSTRUCTIONS BEFORE USING YOUR LIFT-AWAY GARMENT PRO FABRIC STEAMER.



DANGER OF SCALDING

Please use caution when using the fabric steamer. The Wrinkle Eraser™ pressing bar and the steam emitted are very hot. The Wrinkle Eraser™ is hot as long as the unit is turned on and for 30 minutes after the unit has been turned off.

POLARIZED PLUG:

To reduce the risk of electric shock, this appliance has a polarized plug (one blade is wider than the other). As a safety feature, this plug will fit into a polarized outlet only one way. If the plug does not fit fully into the outlet, reverse the plug. If it still does not fit, contact a qualified electrician to install the proper outlet. **Do**

not attempt to defeat this safety feature.

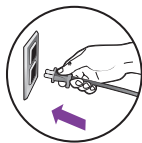

1. **USE THE SYSTEM ONLY FOR ITS INTENDED USE AS DESCRIBED IN THIS MANUAL.**
2. **ONLY USE WATER.** To extend the life of your **Lift-Away Garment Pro Fabric Steamer**, we recommend using distilled water especially if you live in an area with hard tap water.
3. **DO NOT** add cleaning solutions, scented perfumes, oils, or any other chemicals to the water used in this appliance as this may damage the unit or make it unsafe for use.
4. Use of any substances other than manufacturer's recommended accessories will automatically void your warranty.
5. **DO NOT** use outdoors.
6. **DO NOT** leave the appliance unattended when plugged in.
7. Always unplug the power cord from the electrical outlet when not in use, when filling the water tank and before cleaning.
7. Always unplug the power cord from the electrical outlet when not in use, when filling the water tank and before cleaning.
8. **DO NOT** allow to be used as a toy.
9. **DO NOT** put any objects into openings or operate with any opening blocked.
10. **DO NOT** use on leather, suede, vinyl, plastic or other delicate steam sensitive materials. Always determine the colorfastness of any fabric before using the fabric steamer by testing it on a small portion of the garment's underside.
11. This appliance and the accessories become hot during use. Exercise care when changing accessories and follow removal and changing instructions as outlined in the manual. Do not change frames while the unit is turned on. Turn the unit off, wait for the **Wrinkle Eraser™** to cool, and then change frames.





12. The fabric steamer can be used in a vertical or horizontal motion. **NEVER** hold the steam head down while at rest.
13. When cleaning the fabric steamer, unplug the power cord and clean with a dry or damp cloth. **DO NOT** pour water on the unit or use alcohol, benzene or paint thinner on the unit.
14. **NEVER** attempt to steam clothing while it is being worn.
15. To protect against a risk of fire, electric shock, or injury:
 - a. To avoid circuit overload, **DO NOT** operate another appliance on the same socket (circuit) as the fabric steamer.
 - b. **DO NOT** immerse any part of the system in water or other liquids.
 - c. **DO NOT** pull power cord to disconnect from outlet; instead, grasp plug and pull to disconnect.
 - d. **DO NOT** use extension cords or outlets with inadequate current carrying capacity. If an extension cord is absolutely necessary, use a 15-ampere cord. Cords rated for less amperage may overheat. Use care to arrange the cord so that it cannot be pulled or tripped over.
 - e. **DO NOT** operate the system with a damaged cord or plug, or if the appliance or any other part of the system has been dropped or damaged.
 - f. **DO NOT** disassemble or attempt to repair the fabric steamer. Return the system to **EURO-PRO Operating LLC** for examination and repair. Incorrect reassembly or repair can cause a risk of electrical shock or injury to persons when the fabric steamer is used.
 - g. **DO NOT** handle plug or fabric steamer with wet hands or operate without shoes.
 - h. **DO NOT** pull or carry by power cord, use power cord as a handle, close a door on the power cord, or pull the power cord around sharp corners or edges.
 - i. **DO NOT** allow power cord to touch hot surfaces.
 - j. **ALWAYS** disconnect the steamer from electrical outlet when filling the water tank or emptying and when not in use.
 - k. **NEVER** attempt to fill this unit under a water faucet. Always use the funnel that is provided.
 - l. **Never** turn the appliance over or on its side when in use.
 - m. **NEVER** aim or direct steam towards people, animals, or plants. The steam is very hot and can cause burns. Burns can occur from touching hot metal parts, steam, steam bonnets or frames. There may be condensation on the parts of the steamer which may be hot.
 - n. **DO NOT** operate the product while under the influence of drugs, alcohol or medications.
 - o. **DO NOT** operate in the presence of explosive and/or flammable fumes.
 - p. Store your appliance indoors in a cool, dry area out of the reach of children.
 - q. Keep your work area well lit.
 - r. Let the steamer cool completely before putting away. Loop cord loosely on the cord hook on the telescopic pole.
 - s. **Keep out of the reach of children.**

SAVE THESE INSTRUCTIONS

Welcome to the next generation of garment care!

The **Lift-Away Garment Pro Fabric Steamer** provides you the convenience of removing wrinkles right on the hangers; and at the same time press the garments to get a completely finished look. The **Shark®** powerful steam technology penetrates fibers, renews and freshens fabrics. The exclusive heated Wrinkle Eraser™ presses for a crisp finish and dries fibers to prevent re-wrinkling.

With the unique design to be able to steam the garment right on the hanger with the telescopic pole; or lift off from the base to become a table top unit; or carry it around the home to steam upholstery to have a healthy home, the **Lift-Away Garment Pro Fabric Steamer** is an all-in-one solution to make you look the best in the easiest way.



Attaching the appropriate accessory:

The unit comes assembled with a small steam bonnet. The bonnet must be attached at all times when the unit is being used.

- 1 Make sure the small steam bonnet is in place. Loop one side first and then stretch it over to loop over the hook on the other side. Make sure that the steam bonnet is covering the lip of the steam chamber completely. (**Fig. 1**).

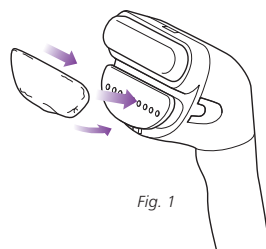
 **TIP:** Wipe away condensation from the steam guard on the bottom of the frame after extended use.



FRAME/ ACCESSORY	Small Steam Bonnet	Bristle Brush Frame	Upholstery/Delicate Fabric Frame & Steam Bonnet
			
USE FOR	The bonnet should always be attached during any use and with any frame	Best for cotton, wool, linen, denim	Best for: lace, velvet, silk, satin, embellished or delicate garments and upholstery
BENEFITS	The specially designed pad protects fabrics from water marks and impurities	Improves steam penetration on heavy fabrics without leaving water marks	Specifically designed to protect delicate fabric from high heat

Quick Start Guide

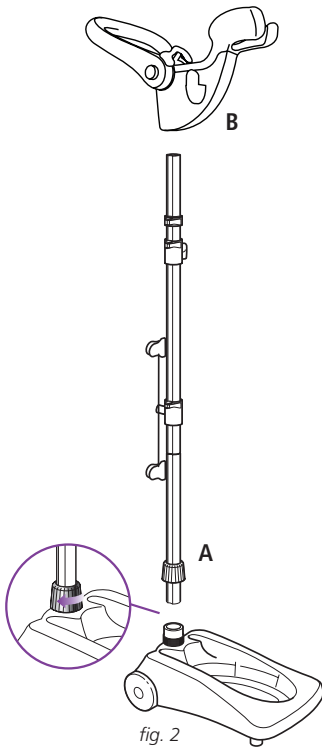

fig. 2

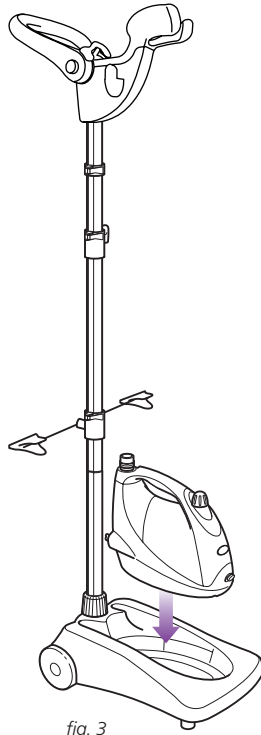

fig. 3

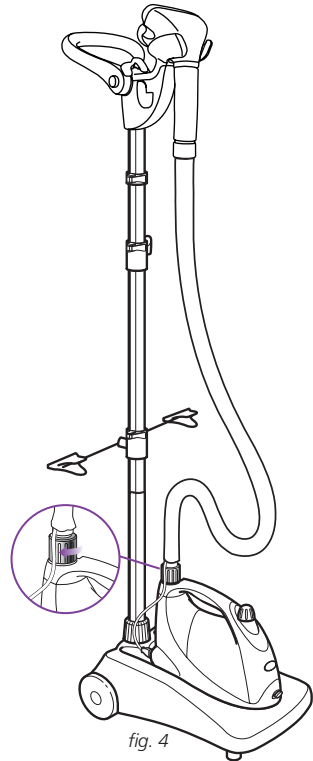

fig. 4

ASSEMBLY

- 1 Set the base on the floor and insert the telescopic pole section (A) into the opening in the base. Align the opening of the telescopic pole with the opening of the base and slide it in. Secure the pole onto the base by turning the connector clockwise. (**fig. 2**)
 - 2 Insert the steam nozzle cradle/handle (B) all the way down the telescopic pole until it stops. The cradle should face the front of the base. (**fig. 2**)
 - 3 Place the portable steamer on the base. Make sure that it sits flat. (**fig. 3**)
 - 4 Attach the steam hose to the steam unit by turning the connector clockwise until it is completely locked. Hang the steam nozzle on the steam nozzle cradle. (**fig. 4**)
- ! NOTE:** The hose will remain stiff until heated.

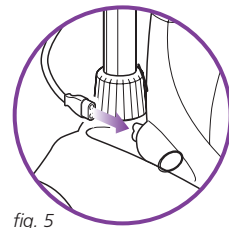
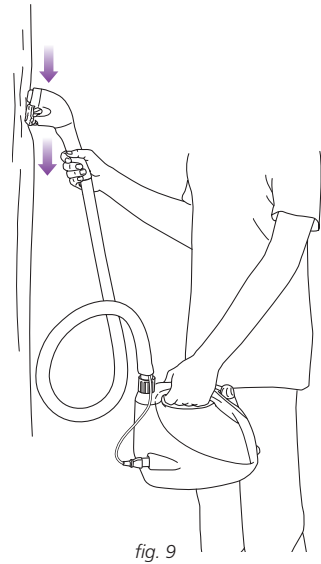
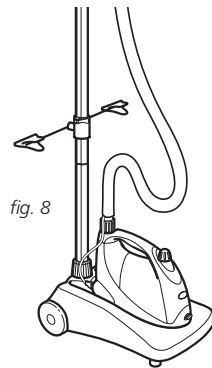
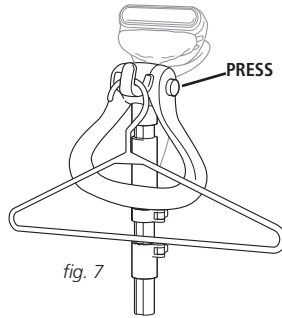
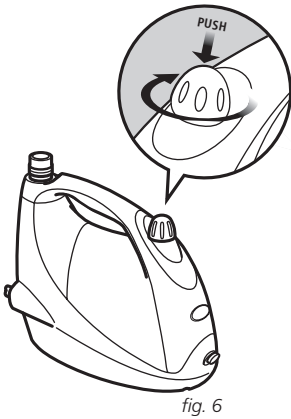

fig. 5

- 5 Plug the steam hose power cord (white) into the fabric steamer receptacle which is on the right side of the steamer. (**fig. 5**) This provides the power to heat up the **Wrinkle Eraser™** after the main power cord (gray) is plugged in.

Quick Start Guide - cont.



FILLING THE WATER TANK

- 1 Make sure the power switch is OFF "0" then unplug the unit from the power outlet.
- 2 Remove the water tank cap by turning counter clockwise and use the funnel that is provided to fill the water tank to the max fill line. (fig. 6)
- 3 Replace the cap on the filling inlet. Push the cap down and turn clockwise to lock. Steam will not emit if the water tank cap is not locked properly.

USING THE STEAMER

Stand Mode

- 1 Make sure the steam bonnet is in place during all usage.
- 2 To lower the handle, push the button on the side of the handle to a locked position. (fig. 7) Hang the garment on the garment hook.
- 3 Adjust the garment clip bar/ down to clip the bottom of the garment for extra support. (fig. 8)
- 4 Begin steaming in an up and down motion.

Portable Mode

- 1 Remove the steamer from the base by lifting it up.
- 2 Hold the steamer at waist level in one hand or place on a table. (Fig. 9)
- 3 Steam the fabric in an up and down motion.



CONTENTS

Thank you
for purchasing
the **Shark®**
Lift-Away
Garment Pro
Fabric Steamer

Quick Start Guide	4
Assembly	6
Using your Fabric Steamer	8
Maintenance	10
Troubleshooting Guide	10
Warranty and Registration	11

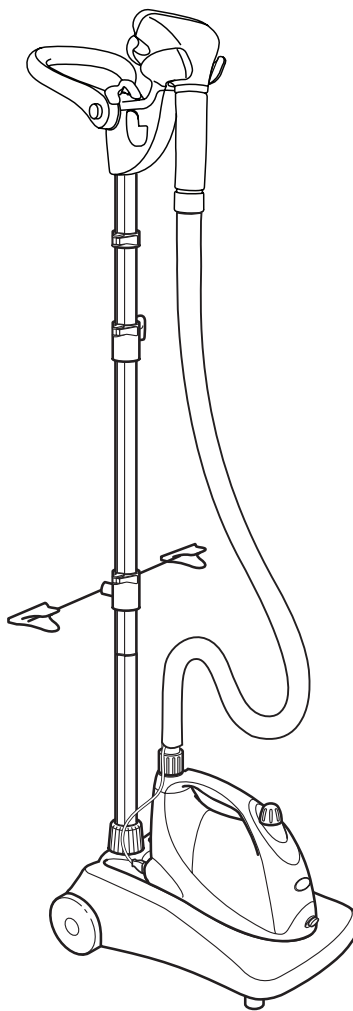

This manual covers model number:
GS400 11

TECHNICAL SPECIFICATIONS

Voltage: 120V., 60Hz.

Power: 1500 Watts

Water Capacity: 1100 ml (37 oz.)

Getting Started

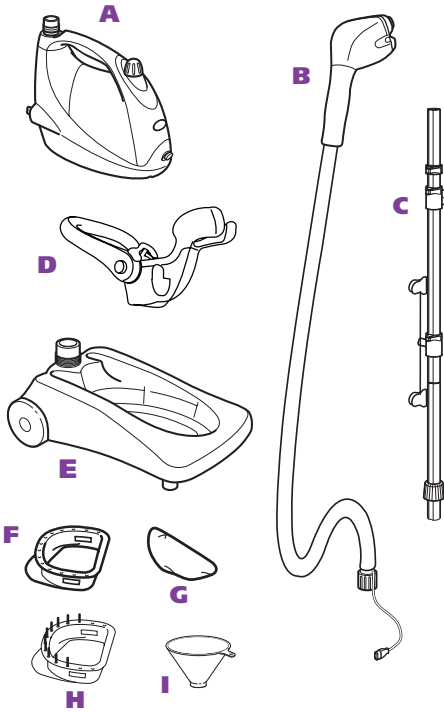

First things first, you need to know what's in the box you just opened:

- A** Fabric Steamer
- B** Steam hose/steam nozzle with steam bonnet (Bonnet is removable)
- C** Telescoping Garment Pole
- D** Steam Nozzle Cradle with Swivel Handle and Garment Hook
- E** Unit Base
- F** Upholstery/Delicate Fabric Frame
- G** Upholstery/Delicate Fabric Bonnet
- H** Bristle Brush
- I** Filling Funnel

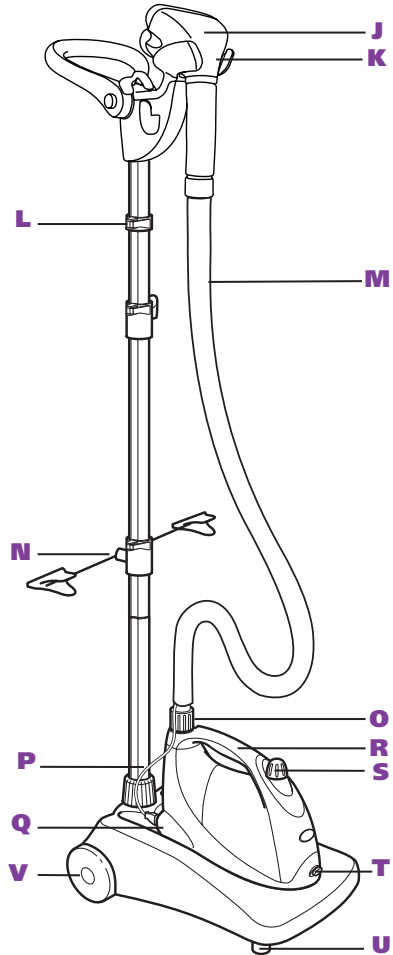

YOUR FABRIC STEAMER FEATURES

- J** Steam Nozzle with Wrinkle Eraser™
- K** Power Indicator
- L** Telescoping Garment Pole Adjustment Clips
- M** Steam Hose with Fabric Cover
- N** Adjustable Garment Clip Bar
- O** Hose Connection
- P** Steam Hose Power Cord (White)
- Q** Steam Hose Power Cord Receptacle
- R** Carrying Handle
- S** Water Tank Cap
- T** Power Switch
- U** 2 Legs
- V** 2 Roller Wheels



Assembly

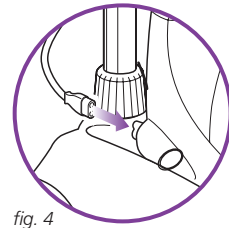
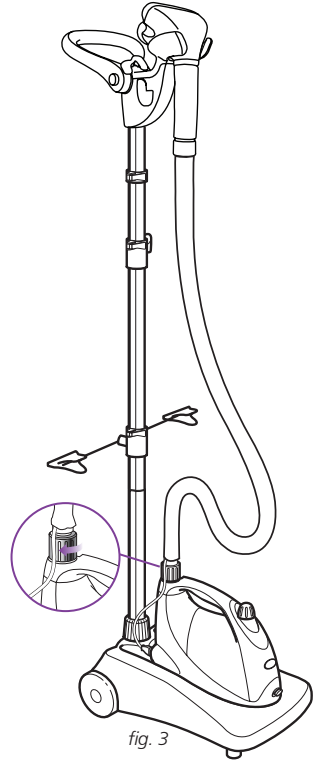
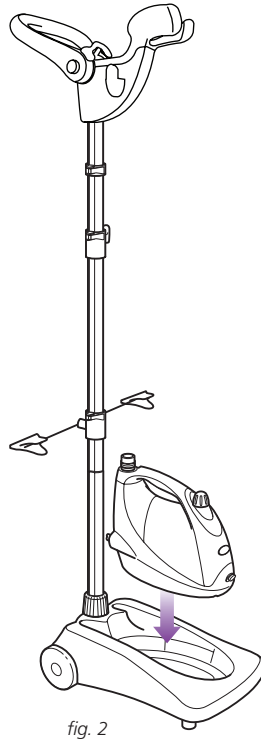
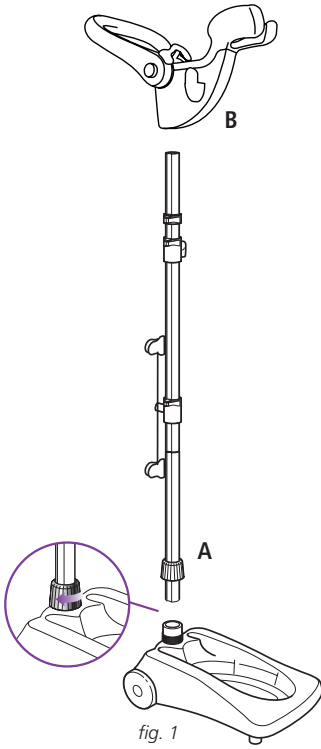

ASSEMBLY

- 1 Set the base on the floor and insert the telescopic pole section (A) into the opening in the base. Align the opening of the telescopic pole with the opening of the base and slide it in. Secure the pole onto the base by turning the connector clockwise. (**fig. 1**)
 - 2 Insert the steam nozzle cradle/handle (B) all the way down the telescopic pole until it stops. The cradle should face the front of the base. (**fig. 1**)
 - 3 Place the portable steamer on the base. Make sure that it sits flat. (**fig. 2**)
 - 4 Attach the steam hose to the steam unit by turning the connector clockwise until it is completely locked. Hang the steam nozzle on the steam nozzle cradle. (**fig. 3**)
- ⚠ NOTE:** The hose will remain stiff until heated.

- 5 Plug the steam hose power cord (white) into the fabric steamer receptacle which is on the right side of the steamer. (**fig. 4**) This provides the power to heat up the **Wrinkle Eraser™** after the main power cord (gray) is plugged in.

Using Your Lift-Away Garment Pro Fabric Steamer

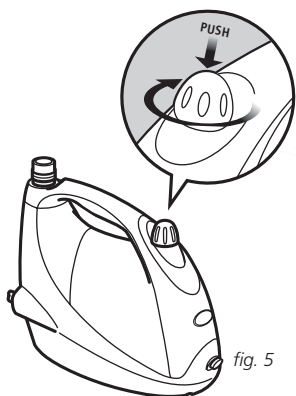

Practice makes perfect! It takes time to master the garment steaming techniques.



For best results, tilt the steamer forward slightly and press the **Wrinkle Eraser™** directly on the garment.

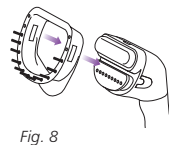
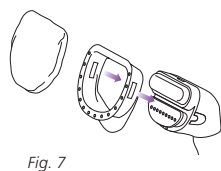
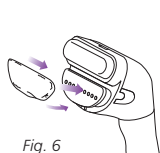

Filling the water tank

- 1 Make sure the power switch is OFF "0" then unplug the unit from the power outlet.
- 2 Remove the water tank cap by turning counter clockwise and use the funnel that is provided to fill the water tank to the max fill line. (fig. 5)
- 3 Replace the cap on the filling inlet. Push the cap down and turn clockwise to lock.

IMPORTANT: The water cap must be locked into place securely to allow proper flow of water. Once turned on, steam will not emit if the water cap is not secure.

WARNING: Do not fill the water tank when the unit is plugged in to an electrical outlet.

WARNING: The steam is hot! Be careful not to touch the steam nozzle when the unit is turned on or has been in use.

IMPORTANT: When assembling your fabric steamer, there may be a little water in the water tank. This is because we test all our fabric steamers 100% before you buy them, so you get a quality Shark® Steam product.



The seam on the frame must line up with the seam on the unit for proper use and safety. The frame will snap into place, double check to make sure the seams are aligned.

Attaching the accessories:

IMPORTANT: Use caution when changing the frame when the unit is hot. The frames are designed with a steam guard around the bottom to provide protection from heat when placing or removing the frames.

The small steam bonnet must be attached at all times during usage. (Fig. 6)

This bonnet should only be removed for washing by hand, if necessary (see page 12 for care instructions).

When using the upholstery/delicate fabric frame:

NOTE: Remember, DO NOT use the fabric steamer without the small steam bonnet in place.

- 4 Attach the Upholstery/Delicate Fabric bonnet to the frame, then attach the frame to the unit. Pull either side of the bonnet over the top of the frame and secure the bottom of the bonnet to the frame. (Fig. 7) Then, attach the frame to the fabric steamer by placing the top of the frame into the notch above the **Wrinkle Eraser™**. Next, secure the rounded end of the frame underneath the steam nozzle and snap into place.

When using the bristle brush frame:

NOTE: The bristle brush offers better steam penetration for heavy fabrics without leaving water marks.

- 5 Attach the bristle brush frame to the fabric steamer nozzle. Make sure that the small steam bonnet is attached. (Fig. 8)

Fabric Recommendations: Heavy fabrics, cotton, wool, canvas, denim.

CAUTION: Do not use the bristle brush on delicate fabrics.



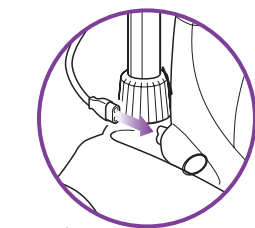

fig. 9

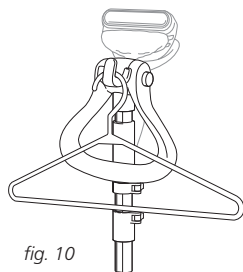

fig. 10

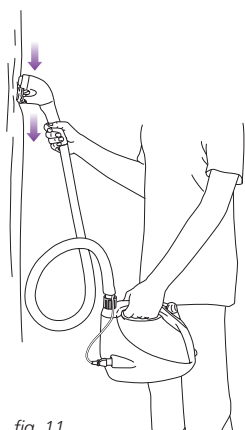

fig. 11

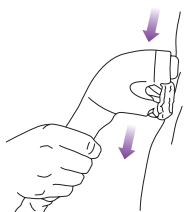

fig. 12

- ⚠ **CAUTION:** The Wrinkle Eraser™ is hot as long as the steam hose power cord (white) is plugged into the steamer receptacle and the unit is turned on.
- ⚠ **CAUTION:** Do not hold the unit in a fixed position on delicate fabrics and upholstered items.
- ⚠ **CAUTION:** The Wrinkle Eraser™ is hot. Use caution when removing the frames. DO NOT put your hands directly onto the Wrinkle Eraser™.
- ⚠ **CAUTION:** Always place the steam nozzle onto the cradle on the stand when not in use. Hot water and condensation may come out if the nozzle is not placed in the upright position.
- ⚠ **WARNING:** Never steam any article of clothing while it is being worn.
- ⚠ **IMPORTANT:** Steam performance will be interrupted if the steam hose is bent for a long period of time or is blocked. Gurgling and condensation may occur.

Stand steaming

- 1 Plug in the steam hose power cord (white) into the fabric steamer receptacle. (Fig. 9)
 - 2 Plug the main power cord (gray) into an electrical outlet and turn the On/Off Switch to the "I" position. The LED light will illuminate.
 - 3 The Wrinkle Eraser™ will heat up and steam will start emitting after 1 minute. The steamer is now ready to use.
 - 4 Hang your desired garment on the garment hook. Begin steaming the garment in an up and down motion pressing the steam nozzle on the fabric. (Fig. 10)
- ⚠ **CAUTION:** Steam hose and spring can become hot during use. Never hold the hose while in use. When steaming garments, hold it always by the steam nozzle.

Portable/tabletop steaming

- 1 Use the steamer in portable or tabletop mode to freshen fabrics all around your home.
- ⚠ **WARNING:** Do not use on leather, suede, or leather like materials.
- 2 Lift off the steamer unit from the base.
 - 3 Plug the steamer into an electrical outlet and turn the unit on. Make sure that the steam hose power cord (white) is plugged into the steamer receptacle.
 - 4 Hold the unit at waist level in one hand or place on a table. (Fig. 11)
 - 5 Begin steaming the fabric, upholstery or garment in an up and down motion pressing the Wrinkle Eraser directly onto the fabric. (Fig. 12)

- 6 The Lift-Away Garment Pro Fabric Steamer can be used to refresh upholstered items: sofa, baby bedding, mattress, car seat, drapes, and more.
- ⚠ **IMPORTANT:** Make sure to hold the water tank level to the floor. The steam hose should be fully extended for best steam results and to avoid gurgling.
 - ⚠ **IMPORTANT:** Always check the fabric care labels for recommendations. Test the fabrics for colorfastness in an inconspicuous place such as an inside seam. Some articles of clothing are better steamed from the underside.
 - ⚠ **IMPORTANT:** Do not place the steamer nozzle on a table or the floor after use. Hot water condensation may accumulate during use and will come out from the nozzle.

Care of Your Lift-Away Garment Pro Fabric Steamer

Cleaning & storing

- 1 Turn the fabric steamer off "0".
- 2 Unplug the appliance from the electrical outlet.
- 3 Let the appliance cool completely for approximately 30 minutes.
- 4 Wipe the exterior of the fabric steamer with a damp cloth and wipe dry if needed.
- 5 Hang the steam nozzle onto the cradle. (Fig. 13)
- 6 Hang the bristle brush frame and the upholstery/delicate fabric frames on either side of the steam nozzle cradle. (Fig. 13)
- 7 Collapse the telescoping pole for compact storage. Always store your appliance in a cool, dry area. Periodically, remove the steam hose from the steam unit and turn the water tank upside down over the sink to empty any excess water. This will prolong the life of the fabric steamer.

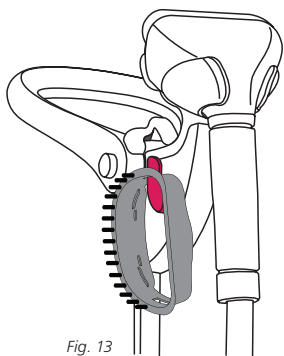

Fig. 13

Care & use of the small steam bonnet

- 8 The steam bonnet helps filter impurities from your water. It might become slightly discolored over time.
- 9 Let the steam nozzle and the **Wrinkle Eraser™** cool completely before removing the steam bonnet. Take off the bonnet from the loops on the sides of the steam nozzle.
- 10 Hand wash the steam bonnet in cold water with a mild detergent and let air dry completely before using again. Do not dry in clothes dryer.
- 11 To re-attach the steam bonnet, loop the steam bonnet on the sides of the steam nozzle. (Fig. 14)

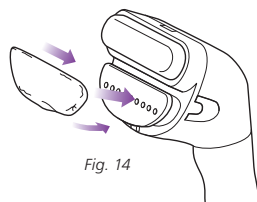

Fig. 14

Troubleshooting Guide

PROBLEM	SUGGESTED SOLUTIONS
<p>There is no steam.</p>	<p>Make sure that the main power cord (gray) for the steamer is plugged into the electrical outlet and the steam hose power cord (white) for the Wrinkle Eraser™ is plugged into the steamer receptacle. Turn the steamer to the On "I" position.</p> <p>Verify that the blue power light on the steam nozzle is lit.</p> <p>Verify that the water tank is at least half way full or fill to the max fill line.</p> <p>The water cap is not fully pushed in. Press the cap down and turn clockwise to secure tightly making sure the arrows are aligned.</p>
<p>The nozzle leaves water drops on the garment.</p>	<p>Make sure that the steam bonnet is in place at all times during usage.</p> <p>The bonnet prevents water drops being left on the garment and removes impurities from your water. However, overuse of the unit will cause oversaturation of the steam bonnet which will cause water drops on the garments.</p> <p>Let the unit cool for 30 minutes, remove the steam bonnet and let it dry out before using again or replace with a new bonnet frame.</p> <p>The steam hose is bent. Straighten the hose to eliminate condensation build up.</p> <p>Let the appliance cool and wipe the frame off.</p>
<p>Gurgling/inconsistent steam flow.</p>	<p>The steam hose may be bent trapping steam or condensation. Simply straighten out the steam hose to eliminate condensation build up.</p> <p>In portable usage, the unit must be level to the floor with the steam hose extended to generate continuous steam.</p>
<p>Unit won't turn on/ Wrinkle Eraser™ will not get hot.</p>	<p>Make sure the main power cord (gray) is plugged in and the unit is turned to the On "I" position.</p> <p>Make sure that the steam hose power cord (white) for the Wrinkle Eraser™ is plugged into the steamer receptacle and the blue power light on the steam nozzle is lit.</p>



Replacement Parts



Ordering replacement parts:

To order additional parts and accessories, feel free to contact us at www.sharkclean.com or call **1-800-798-7398**.

PART	PART NO.
a Small Steam Bonnet	XBN400
b Upholstery/Delicate Fabric Frame	110GSO
c Delicate Fabric/ Upholstery Steam Bonnet	XPD400
d Bristle Brush	109GSO



Euro-Pro One (1) Year Limited Warranty

EURO-PRO Operating LLC warrants this product to be free from defects in material and workmanship for a period of one (1) year from the date of the original purchase, when utilized for normal household use, subject to the following conditions, exclusions and exceptions.

If your appliance fails to operate properly while in use under normal household conditions within the warranty period, return the complete appliance and accessories, freight prepaid to:

- **U.S.: EURO-PRO Operating LLC**
For customer service support call 1-800-798-7398
or visit www.sharkclean.com
- **Canada: EURO-PRO Operating LLC**
4400 Bois Franc, St. Laurent, Québec H4S 1A7

If the appliance is found to be defective in material or workmanship, **EURO-PRO Operating LLC** will repair or replace it free of charge. Proof of purchase date and a check made payable to **EURO-PRO Operating LLC** in the amount of \$19.95 to cover the cost of return shipping and handling must be included.*

Non-durable parts including, without limitation, filters, brushes and electrical parts which normally require replacement are specifically excluded from warranty.

The liability of **EURO-PRO Operating LLC** is limited solely to the cost of the repair or replacement of the unit at our option. This warranty does not cover normal wear of parts and does not apply to any unit that has been tampered with or used for commercial purposes. This limited warranty does not cover damage caused by misuse, abuse, negligent handling or damage due to faulty packaging or mishandling in transit. This warranty does not cover damage or defects caused by or resulting from damages from shipping or repairs, service or alterations to the product or any of its parts, which have been performed by a repair person not authorized by **EURO-PRO Operating LLC**.

This warranty is extended to the original purchaser of the unit and excludes all other legal and/or conventional warranties. The responsibility of **EURO-PRO Operating LLC** if any, is limited to the specific obligations expressly assumed by it under the terms of the limited warranty. In no event is **EURO-PRO Operating LLC** liable for incidental or consequential damages of any nature whatsoever. Some states do not permit the exclusion or limitation of incidental or consequential damages, so the above may not apply to you.

This warranty gives you specific legal rights, and you may also have other rights which vary from state to state or province to province.

***IMPORTANT: Carefully pack item to avoid damage in shipping. Be sure to include proof of purchase date and to attach tag to item before packing with your name, complete address and phone number with a note giving purchase information, model number and what you believe is the problem with item. We recommend you insure the package (as damage in shipping is not covered by your warranty). Mark the outside of your package "ATTENTION CUSTOMER SERVICE". We are constantly striving to improve our products, therefore the specifications contained herein are subject to change without notice.**

Product Registration

Please visit www.sharkclean.com or call **1-800-798-7398** to register your new Shark® product within ten (10) days of purchase. You will be asked to provide the store name, date of purchase and model number along with your name and address.

The registration will enable us to contact you in the unlikely event of a product safety notification. By registering you acknowledge to have read and understood the instructions for use, and warnings set forth in the accompanying instructions.



Euro-Pro Operating LLC
US: Newton, MA 02459
CAN: Ville St-Laurent, QC H4S 1A7

English: 1-800-798-7398

www.sharkclean.com

Copyright © 2011 Euro-Pro Operating LLC

Printed in China

Illustrations may differ from actual product.

GS400.E.120111.1