

Shark **GENIUS™**

S5002Q

OWNER'S GUIDE



 [registeryourshark.com](https://www.registeryourshark.com)

 1-800-798-7398

IMPORTANT SAFEGUARDS

HOUSEHOLD USE ONLY • READ ALL INSTRUCTIONS BEFORE USE

WHEN USING YOUR SHARK® GENIUS™ STEAM POCKET® MOP SYSTEM, BASIC SAFETY PRECAUTIONS SHOULD ALWAYS BE FOLLOWED, INCLUDING THE FOLLOWING:

READ ALL INSTRUCTIONS BEFORE USING YOUR SHARK GENIUS STEAM POCKET MOP SYSTEM.

 **WARNING: DANGER OF SCALDING.** The steam emitted from the Steam Mop is very hot and may cause scalding. Please use caution when using the Steam Mop.

 **WARNING: KEEP STEAM MOP AWAY FROM CHILDREN.**

POLARIZED PLUG:

This Steam Mop has a polarized plug (one blade is wider than the other). As a safety feature, this plug will fit into a polarized outlet only one way. If the plug does not fit fully into the outlet, reverse the plug. If it still does not fit, contact a qualified electrician. **DO NOT** attempt to defeat this safety feature. It is not recommended to use an extension cord with this product.

 **WARNING: TO REDUCE THE RISK OF FIRE, ELECTRIC SHOCK OR INJURY:**

1. When in use, **NEVER** turn the Steam Mop over on its side or direct steam toward people, pets or plants.
2. Use the system only for its intended use.
3. **DO NOT** use for space-heating purposes.
4. **DO NOT** use outdoors.
5. **DO NOT** leave the Steam Mop unattended when plugged in. **ALWAYS** unplug the power cord from the electrical outlet when not in use and before servicing.
6. **DO NOT** allow the Steam Mop to be used by children. Close attention is necessary when used near children, pets, or plants.
7. Use only as described in this owner's guide.
8. Use only manufacturer's recommended accessories.
9. **DO NOT** use with damaged cord or plug. If Steam Mop is not working as it should or has been dropped, damaged, left outdoors, or dropped into water, return it to SharkNinja Operating LLC for examination and repair. Incorrect reassembly or repair can cause a risk of electrical shock or injury.
10. To protect against a risk of electric shock, **DO NOT** immerse the Steam Mop in water or any other liquids.
11. **DO NOT** handle the plug or Steam Mop with wet hands or operate it without wearing shoes.

IMPORTANT SAFEGUARDS

HOUSEHOLD USE ONLY • READ ALL INSTRUCTIONS BEFORE USE

12. **DO NOT** pull or carry by cord, use cord as a handle, close a door on cord, or pull cord around sharp edges or corners. **DO NOT** run Steam Mop over cord. Keep cord away from heated surfaces.
13. **DO NOT** unplug by pulling on power cord. To unplug, grasp the plug not the power cord. **DO NOT** use extension cords or outlets with inadequate current-carrying capacity.
14. **DO NOT** put any objects into the steam nozzle openings. Discontinue use if the steam nozzle is blocked.
15. **DO NOT** put hands or feet under the Steam Mop. It gets very hot.
16. Use **ONLY** on flat, horizontal surfaces. **DO NOT** use on walls, counters, or windows.
17. **DO NOT** use on leather, wax-polished furniture, synthetic fabrics, velvet, or other delicate, steam-sensitive materials.
18. **DO NOT** add cleaning solutions, scented perfumes, oils, or any other chemicals to the water used in the Steam Mop as this may damage it or make it unsafe for use. If you live in a hard-water area, we recommend using distilled water in your Steam Mop.
19. **NEVER** leave any Dirt Grip™ pad in one spot while using or storing for an extended period of time, as this may damage your surfaces.
20. You can release the Dirt Grip pad after you have unplugged the Steam Mop and allowed it to cool.
21. When cleaning the exterior of the Steam Mop, unplug the power cord from the electrical outlet and clean the Steam Mop with a dry or damp cloth. **DO NOT** pour water or use alcohol, benzene, or paint thinner on the Steam Mop.
22. Extreme caution should be exercised when using the Steam Mop to clean stairs.
23. **NEVER** use Steam Mop without the Dirt Grip pad attached.
24. Keep your work area well lit.
25. Store Steam Mop indoors in a cool, dry place.
26. To avoid circuit overload, **DO NOT** operate another appliance on the same socket (circuit) as the Steam Mop.
27. To avoid scalding injuries, **ALWAYS** unplug and allow the Steam Mop to cool before removing or changing mop heads, accessories, or Dirt Grip pads.

 **WARNING:** Your Steam Mop is designed to clean hard-floor surfaces that will withstand high heat. **DO NOT** use on unsealed wood or unglazed ceramic floors. On surfaces that have been treated with wax and on some unwaxed floors, the sheen may be removed by the heat and steam action. We recommended testing an isolated area of the surface to be cleaned before proceeding. We also recommend that you check the use and care instructions from the floor manufacturer.



SAVE THESE INSTRUCTIONS

THANK YOU

Thank you for purchasing the Shark® Genius™ Steam Pocket® Mop System.



REGISTER YOUR PURCHASE

-  registeryourshark.com
-  1-800-798-7398
-  Scan QR code using mobile device

RECORD THIS INFORMATION

Model Number: _____
Serial Number: _____
Date of Purchase: _____
(Keep receipt)
Store of Purchase: _____

THIS BOOK COVERS MODEL NUMBER:

S5002Q

TECHNICAL SPECIFICATIONS

Voltage: 120V~, 60Hz
Power: 1050 Watts
Water Capacity: 350 ml (11.8 oz.)

PLEASE READ CAREFULLY AND KEEP FOR FUTURE REFERENCE.

These instructions are designed to help you get a complete understanding of your new Shark Genius Steam Pocket Mop System.

If you have any questions, please visit sharkclean.com or call our Customer Service line at 1-800-798-7398.

TIP: You can find the model and serial numbers on the QR code label located on the back of the unit by the power cord.

CONTENTS

Parts	2
Assembling Your Steam Pocket® Mop	4
Using Your Steam Pocket Mop.	6
Automatic Steam Control	7
Caring For Your Steam Pocket Mop.	8
Ordering Additional Accessories	9
Troubleshooting Guide	10
Warranty	13

PARTS

- A** Steam Mop Handle
- B** Quick-Release Cord Holder
- C** Cord Management Clip
- D** Filling Flask
- E** Steam Mop Pad Release Button
- F** Steam Mop Body
- G** Water Tank Lid
- H** Steam Button
- I** Water Tank
- J** Mop Head Release Button
- K** Secondary Release Buttons
- L** Steam Blaster™ Nozzle
- M** Genius™ Mop Head
- N** Dirt Grip™ Pad

When assembling your Steam Mop there may be a little water in or around the water tank. This is because we test all our Steam Mops before you buy them, so you get a quality **Shark® Genius™ Steam Pocket® Mop System**.

PARTS

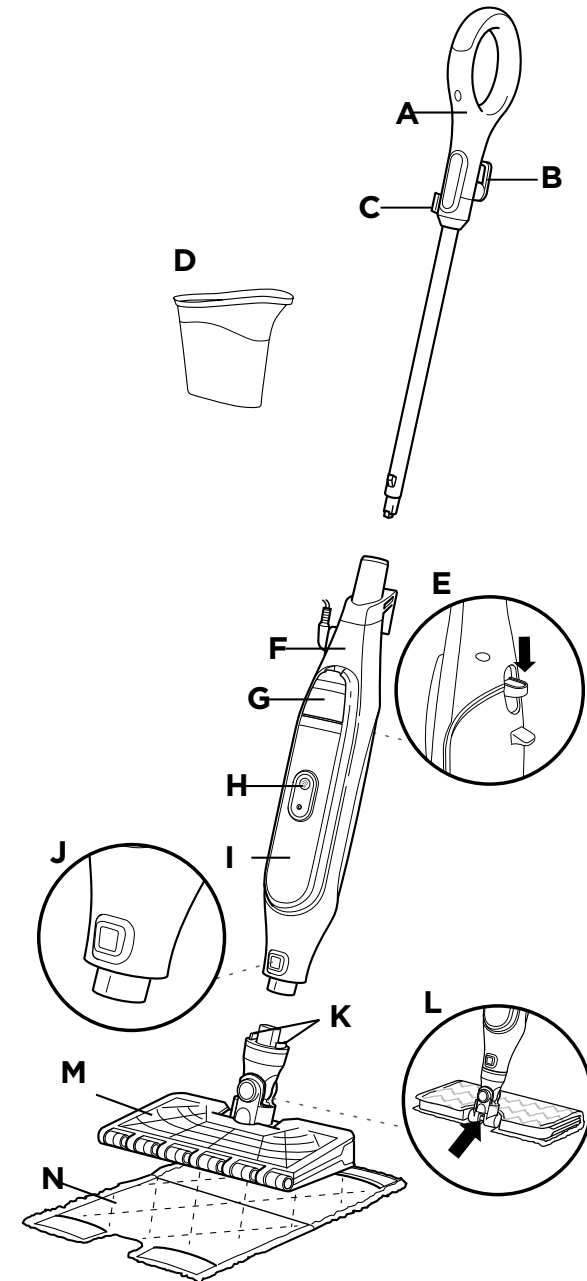

ASSEMBLING YOUR STEAM POCKET® MOP

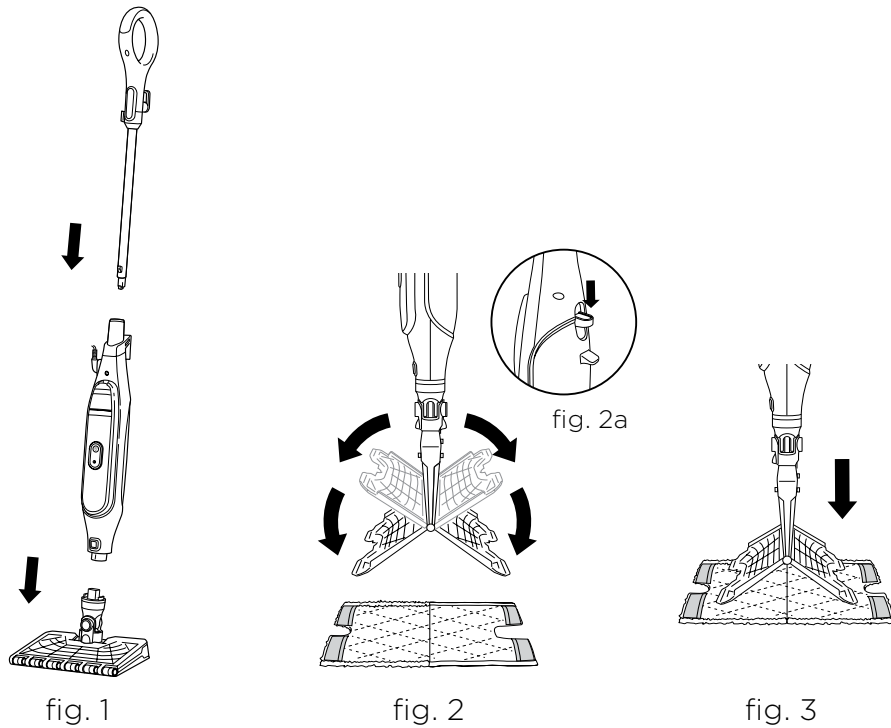

STEAM MOP ASSEMBLY

- 1 Insert the Steam Mop handle into the Steam Mop body. Push the handle in until it clicks into place. **(fig. 1)**
- 2 Slide the Genius™ Mop Head into the Steam Mop body. Push until it clicks securely into place. **(fig. 1)** To detach the Genius Mop Head, press the release button and slide off.
- 3 To attach the Dirt Grip™ pad, spread the pad on the floor with the pocket side up. Center the Genius Mop Head above the pad, then press the pad release button on the back of the Steam Mop body **(fig. 2a)**. Both sides of the Genius Mop Head will drop open **(fig. 2b)**. Slip the Genius Mop Head's four corner tabs into the four corner pockets of the pad **(fig. 3 and fig. 4)**. Gently press one side of the Genius Mop Head to the floor until that side clicks into place **(fig. 5)**. Repeat on the other side **(fig. 6)**.

ASSEMBLING YOUR STEAM POCKET® MOP

▲ WARNING: ALWAYS make sure the Steam Mop is UNPLUGGED when not in use. **NEVER** fill the Steam Mop or attach the mop head when the Steam Mop is plugged into an electrical outlet. Unplug from the electrical outlet and allow to cool before you fill the Steam Mop, or attach or remove the head. To prolong the life of your Steam Mop, we recommend using distilled water. Add only water to the tank. Chemicals or cleaning solutions (including vinegar) may damage the Steam Mop and could be unsafe for you and your family.

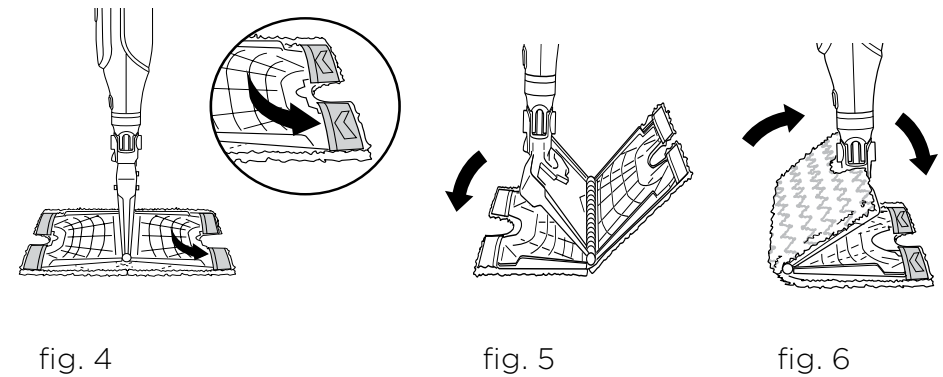

- 4 Pull down on the water tank lid to open **(fig. 7)**.
- 5 Use the filling flask to pour water into the water tank **(fig. 8)**. Water can be poured into the tank directly. **DO NOT** fill past the line on the fill flask. Press the water tank lid firmly to close it.

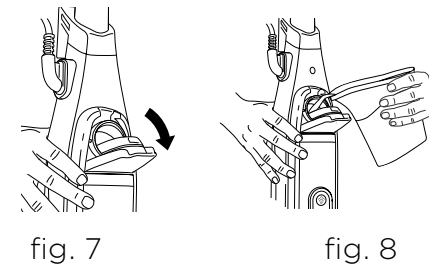

USING YOUR STEAM POCKET® MOP

AUTOMATIC STEAM CONTROL

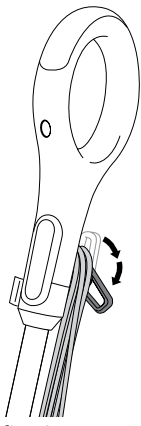

fig. 9

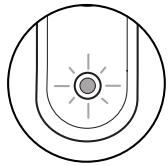

fig. 10a

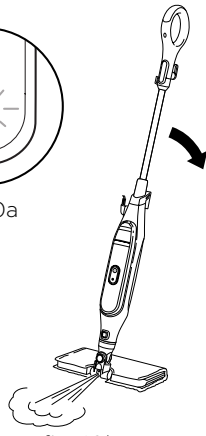

fig. 10b

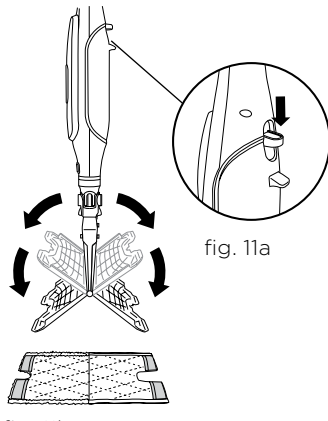

fig. 11a

fig. 11b

NOTE: To prolong the life of your Steam Mop, we recommend using distilled water.

NOTE: Sweep or vacuum your floors prior to cleaning with your Steam Mop.

- 1 Twist the Quick-Release Cord Holder to unwrap the power cord completely (fig. 9). Plug into an electrical outlet.
- 2 When it's first plugged in, the unit will be in Standby mode. When in Standby, the blue light below the Steam Button will blink (fig. 10a).
- 3 When ready to activate steam, press the Steam Button on the Steam Mop body to activate. The blue light will stop blinking and will glow steadily.
- 4 Clean your floors with a forward and backward motion.
- 5 When you need an extra burst of steam to clean a stuck-on stain, you can use the Steam Blaster™ feature. Flip the head over so that it is behind the mop body, then tilt the mop handle down. This will cause the Steam Blaster (fig. 10b) to emit a concentrated blast of steam onto the stain.

⚠ **CAUTION:** While in Steam Blaster mode, **DO NOT** leave stationary for more than one minute.

⚠ **CAUTION: DO NOT** scrub any one area for an extended period of time.

- 6 To stop the Steam Blaster™ spray, simply raise the handle. You can then flip the mop head back into its original position and continue cleaning.
- 7 When finished mopping, press the Steam Control button. The blue light will blink, indicating that the unit is in Standby mode. Once in Standby mode, unplug the unit.
- 8 To remove the Dirt Grip™ pad, lift the Steam Mop straight up by the handle until the Genius™ Mop Head is hanging straight down. Press the Release button on the back of the Steam Mop body (fig. 11a), and both sides of the head will drop open, releasing the pad (fig. 11b).
- 9 Once the Dirt Grip pad has been released, close the Genius Mop Head. To close, gently press one side of the Genius Mop Head to the floor until that side clicks into place. Repeat on the other side.
- 10 When the water tank is empty, the Steam Mop will stop producing steam. You can refill the water tank at any time as long as the Steam Mop is unplugged. Follow the water tank filling instructions on page 5.

NOTE: Please wait 2 to 3 minutes for the Steam Mop to cool off before removing the mop head. **NEVER** leave the Steam Mop with a damp/wet Dirt Grip pad on any floor for an extended period of time.

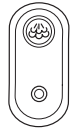
SETTING	IDEAL FOR THESE SEALED SURFACES	RECOMMENDED USAGE
1-setting Automatic Steam Control 	Laminate Hardwood Marble Tile Stone	Cleaning sealed surfaces and large areas Basic, everyday cleaning Removing spots and smaller messes Cleaning moderate and heavy traffic areas
Steam Blaster™	For an extra burst of steam, you can use the Steam Blaster feature. Follow the instructions in Step 5 of the "Using your Steam Pocket® Mop" section.	

TO SANITIZE* WITH THE STEAM MOP USING THE GENIUS™ MOP HEAD AND THE DIRT GRIP™ PAD:

- 1 Attach a clean Dirt Grip pad to the Genius Mop Head.
- 2 Plug the unit in and press the Steam Button on the mop body to activate.
- 3 Wait 30 seconds for the unit to begin producing steam.
- 4 Start mopping on an appropriate sealed hard-floor surface with a forward and backward motion. After three minutes, your unit is ready to be used to sanitize.
- 5 Using a forward and backward motion, move the unit slowly and evenly over the area to be sanitized while applying continuous downward pressure. Slowly repeat at least 3 times.

* Sanitization studies were conducted under controlled test conditions. Household conditions and results may vary. Genius Mop Head only when used with Steam Mop. Not in Steam Blaster™ mode.

IMPORTANT: DO NOT use the Steam Mop without attaching a Dirt Grip pad and adding water to the water tank first. When you are using the Steam Mop for the first time, it might take longer than the normal 30 seconds to start steaming.

IMPORTANT: DO NOT use on unsealed wood or unglazed ceramic floors. On surfaces that have been treated with wax and on some unwaxed floors, the sheen may be removed by the heat and steam action. Test an isolated area of the surface to be cleaned before proceeding. Check the use and care instructions from the floor manufacturer.

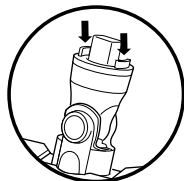

fig. 12



fig. 13

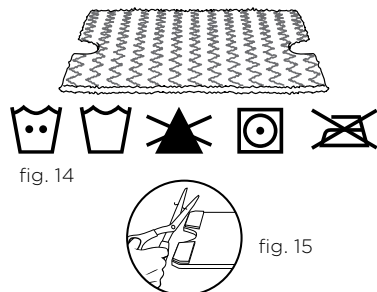

fig. 14

fig. 15

DIRT GRIP™ PAD CARE INSTRUCTIONS

Care

Machine-wash the Dirt Grip pads separately with warm water using liquid detergent.

NEVER USE BLEACH, POWDERED DETERGENT, OR FABRIC SOFTENERS

as they may damage or leave a coating on the Dirt Grip pads that will reduce their cleaning performance and absorbency. Dirt Grip pads should be line-dried or tumble-dried on a low setting, as this will extend the life of the microfiber fabric (fig. 14).

Loose fibers can indicate wearing of the microfiber fabric. **DO NOT** pull the loose fibers, as this can cause the weave to come undone. Simply trim the loose fibers with scissors (fig. 15).

Replacement Dirt Grip pads

For best cleaning results, we recommend replacing your Dirt Grip pads every 3 to 4 months following normal use. As with any fabric, dirt particles, grease, friction, and repeated washing can cause the fibers to break down, and you may notice an increase in the effort needed to push or pull the Steam Mop.

You can purchase replacement Dirt Grip pads and other accessories by visiting sharkaccessories.com or calling 1-800-798-7398.

STEAM NOZZLE CARE

If you believe the main steam nozzle or the Steam Blaster™ nozzle is clogged, please contact Customer Service at 1-800-798-7398.

AFTER USE AND STORAGE

- 1 Press the Steam Control button until the light below starts to blink, indicating that you are in Standby mode. Unplug the cord from the outlet. Place the Steam Mop in an upright position and let cool for 2 to 3 minutes.
- 2 To remove the Dirt Grip™ pad, lift the Steam Mop straight up by the handle until the Genius™ Mop Head is hanging straight down. Press the Release button on the back of the Steam Mop body, and both sides of the Genius Mop Head will drop open, releasing the pad. Once the pad has been released, close the Genius™ Mop Head.
- 3 If the Genius Mop Head is not attached to the mop, the pad can still be removed. Press the two red secondary pad release buttons located on the sides of the Genius Mop Head post to release the pad (fig. 12).
- 4 Empty the water tank before storing. To empty the tank, open the water tank lid and pour water from the tank into a sink. When all the water is out of the tank, close the lid.
- 5 To store the Steam Mop, wait until after it has cooled and the steam has been released. Then remove the Genius Mop Head and hang the Steam Mop by its handle on a large hook (not included) (fig. 13).

ACCESSORY

Genius™ Mop Head

Great for all-purpose cleaning. Get an extra boost for tough stains from the Steam Blaster™.

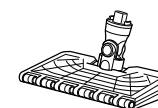

Dirt Grip™ Pad

Double-sided pad. Easy, hands-free installation and removal. Washable and reusable.

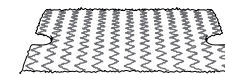

Triangle Scrubber Head

Triangle shape is perfect for cleaning corners and hard-to-reach areas. Equipped with a Steam Blaster to help loosen stains and a deployable scrubber to tackle stuck-on spots.

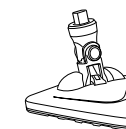

Triangle Scrubber Pad

Ideal for cleaning corners and other hard-to-reach spaces. Easy to install and remove.

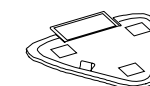

Filling Flask

Makes it simple and convenient to fill the water tank.



TROUBLESHOOTING GUIDE

The Steam Mop isn't producing any steam.

- The Steam Mop should be securely plugged into an electrical outlet. Check your fuse or circuit breaker or try a different outlet.
- Make sure the water tank is full, the unit is plugged in, and the light below the Steam Button is illuminated steadily.
- If the light below the Steam Button is not illuminated, try a different electrical outlet.
- If light below the Steam Button is blinking, the Steam Mop is in Standby mode.
- If the light below the Steam Button is illuminated steadily, wait 30 seconds for the unit to warm up.
- If after following the above steps the Steam Mop still does not produce any steam, contact Customer Service at 1-800-798-7398.

The Steam Mop is producing intermittent steam.

- Make sure the water tank is full.

I am getting streaky/cloudy floors.

- The Dirt Grip™ pad might be dirty. If it is, flip it over to the clean side or change it entirely. If you washed the Dirt Grip pad with powdered detergent, then it could be damaged and require replacement.
- This could also be an indication of soap or grease residue that has accumulated on the floor. As the Steam Mop uses only a small amount of water, it may not be enough to rinse off the accumulation of residue that the steam is bringing to the surface. We suggest rinsing the floor with water only, letting it dry, and then steam mopping again with a clean Dirt Grip pad. One or more rinses will generally remove the residue.
- A more stubborn case may require you to rinse the floor with a mix of one part vinegar and two parts water* (but **DO NOT** put any cleaning solutions or chemicals into the Steam Mop's water tank.)

*Please consult your flooring manufacturer's care and maintenance instructions before applying any cleaning products or solutions.

It's hard to push/pull the Steam Mop.

- The Steam Mop might be hard to push/pull if the Dirt Grip pad isn't wet enough. It should get easier to push/pull the Steam Mop after it's been running for a few minutes.
- An overly dirty pad could also result in a harder push/pull experience. We recommend flipping the pad over or using a clean pad.

TROUBLESHOOTING GUIDE

Can I use the Steam Mop on carpets?

- No, the Steam Mop is not designed for carpet cleaning.

What surfaces can I use the Steam Mop on?

- The Steam Mop is designed for use on all sealed hard-floor surfaces. We recommend that you first test an isolated area of the floor surface to be cleaned as well as review the use and care instructions from your floor manufacturer.

▲ WARNING: DO NOT use on leather, wax-polished furniture, synthetic fabrics, velvet, or other delicate, steam-sensitive materials.

NOTE: On surfaces treated with wax and on some unwaxed floors, the sheen may be removed by the heat or steam action of the unit. Test an isolated area of flooring first to see if sheen is affected.

Can I put something other than water in the water tank?

- **DO NOT** add cleaning solutions, scented perfumes, oils, or any other chemicals to the water used in this appliance, as this may damage the unit or make it unsafe for use. We recommend using distilled water in your Steam Mop.

The 1-Year Limited Warranty applies to purchases made from authorized retailers of **SharkNinja Operating LLC**. Warranty coverage applies to the original owner and to the original product only and is not transferable.

SharkNinja warrants that the unit shall be free from defects in material and workmanship for a period of 1 year from the date of purchase when it is used under normal household conditions and maintained according to the requirements outlined in this instruction manual, subject to the following conditions and exclusions.

What is covered in my warranty?

1. The original unit and/or non-wearable components deemed defective, in SharkNinja's sole discretion, will be repaired or replaced for up to 1 year from the original purchase date.
2. In the rare event that a replacement unit is issued, the warranty coverage ends six months following the receipt date of the replacement unit, or the remainder of the existing warranty, whichever is greater. If the unit is replaced, SharkNinja reserves the right to replace the unit with one of equal or greater value.

What is not covered in my warranty?

Our Customer Care/Product Specialists are available to provide all the warranty service options available to you, including the possibility of upgrading to our VIP Warranty Service Options for select product categories.

1. Normal wear and tear of wearable parts such as foam filters, HEPA filters, pads, batteries, etc., which require regular maintenance and/or replacement to ensure the proper functioning of your unit, are not covered by this warranty.
2. Any unit that has been tampered with or used for commercial purposes.
3. SharkNinja will cover the cost for the customer to send in the unit to us for repair or replacement. A fee of \$19.95 for return shipping costs will be charged at the time of return shipment of the repaired or replacement unit.
4. Damage caused by misuse, abuse, or negligent handling, or damage due to mishandling in transit.
5. Consequential and incidental damages.
6. Defects caused by or resulting from damages from shipping or repairs, service, or alteration to the product or any of its parts which have been performed by a repair person not authorized by SharkNinja.
7. Products purchased, used or operated outside of North America.

Problems with your unit/How to get service

1. If your appliance fails to operate properly while in use under normal household conditions within the warranty period, visit sharkclean.com/support for product care/maintenance self-help. Our Customer Care and product specialists are also available at 877-581-7375 to assist with product support and warranty service options.

How to initiate a warranty claim

You can call 800-798-7398 to have a Customer Care specialist assist you. Please note, you must call 800-798-7398 to initiate a warranty claim. Return and packing instruction information will be provided at that time.

Replacement batteries are available for purchase at sharkclean.com/batteries.

How state law applies

This warranty gives you specific legal rights, and you also may have other rights that vary from state to state. Some states do not permit the exclusion or limitation of incidental or consequential damages, so the above may not apply to you.

Product Registration

Please visit registryyourshark.com or call 1-800-798-7398 to register your new Shark® product within ten (10) days of purchase. You will be asked to provide the store name, date of purchase, and model number, along with your name and address.

The registration will enable us to contact you in the unlikely event of a product safety notification. By registering, you acknowledge you have read and understood the instructions and the accompanying warnings set forth in this owner's guide.



SharkNinja Operating LLC
US: Needham, MA 02494
1-800-798-7398
sharkclean.com

Illustrations may differ from actual product. We are constantly striving to improve our products, therefore the specifications contained herein are subject to change without notice.

For SharkNinja U.S. Patent information, visit sharkninja.com/uspatents.

SHARK and STEAM POCKET are registered trademarks of SharkNinja Operating LLC.

DIRT GRIP, GENIUS, and STEAM BLASTER are trademarks of SharkNinja Operating LLC.

© 2018 SharkNinja Operating LLC
S5002Q_IB_REV_Mv1
PRINTED IN CHINA



@sharkcleaning