

Please be sure to read the enclosed Shark® Owner's Guide prior to using your unit.

Shark ROTATOR® LIFT-AWAY® Pet with Self-Cleaning Brushroll

QUICK START GUIDE

WHAT'S INSIDE

- A** Vacuum Pod
- B** Motorized Floor Nozzle
- C** Handle & Hose
- D** Wand
- E** Double Accessory Holder
- F** 12" Crevice Tool
- G** Upholstery Tool
- H** Pet Power Brush

ASSEMBLY

1. Insert double accessory holder into the side of the pod above the Lift-Away button.
2. Place pod onto floor nozzle post.
3. Insert wand into pod.
4. Insert handle into wand.
5. Attach hose clip to wand.
6. Connect hose to back of pod.

NOTE: For proper operation, ensure all parts are firmly CLICKED into place.

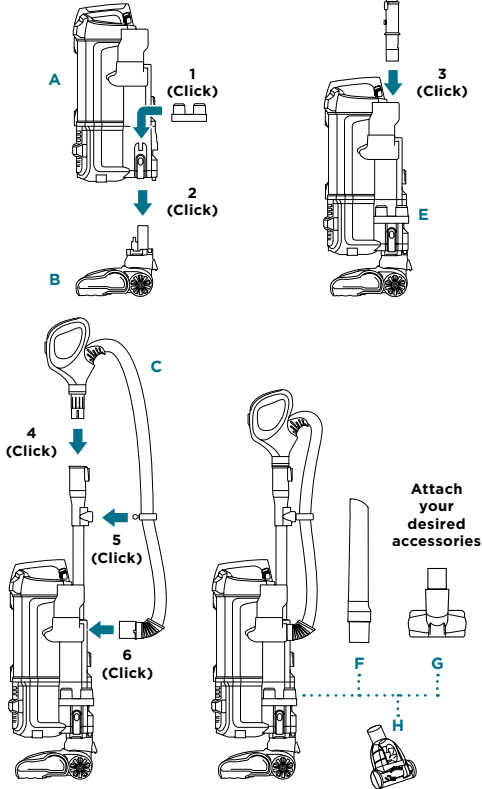

2 WAYS TO CLEAN

UPRIGHT

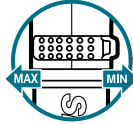

Suction Control

Slide to MIN to increase maneuverability on carpets.

Slide to MAX for more suction on bare floors.



Power/Surface switch

Press switch to select surface setting or to turn off power. To engage brushroll, step on floor nozzle and tilt handle back.

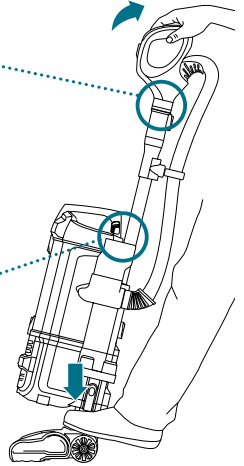

LIFT-AWAY®

Press release buttons to lift pod off nozzle, or to release handle or wand.



Handle Release



Wand Release



Lift-Away Release

Attach accessories to handle or wand.

For additional parts and accessories, visit sharkaccessories.com

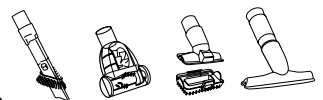

EMPTYING THE DUST CUP

Empty the dust cup after each use.

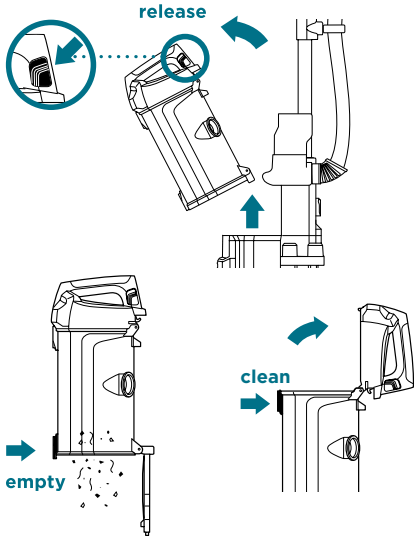

MAINTENANCE:
Rinse pre-motor filters every 3 months, and HEPA filter once a year. Rinse with water only, and allow to air-dry completely before reinstalling.

See enclosed Owner's Guide for more information on how to clean and replace the filters.

TIPS



For quick cord access, rotate upper hook down and remove cord.

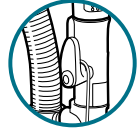

Move cord hook to upright position to secure cord in place.



To store your vacuum, wrap cord around upper and lower hooks.

CHECKING FOR BLOCKAGES

If any hair is wrapped around brushroll, extending cleaning time will help it clear.

Brushroll access

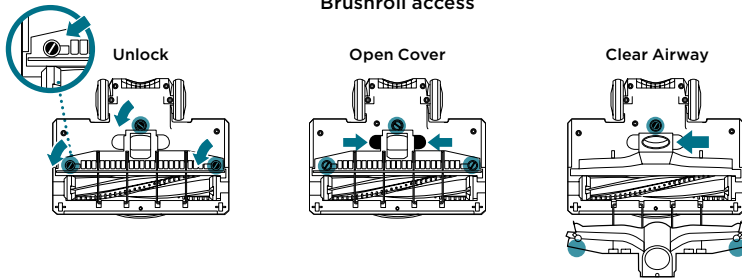

Using a coin, turn locks counterclockwise to open, then lift off cover to access brushroll.

Clear blockages from airway.

Replace cover, pressing down firmly on all sides before turning locks clockwise to close.

Self-Cleaning Brushroll

The Shark® self-cleaning brushroll delivers nonstop hair removal. Check for blockages or objects stuck in the brushroll.

For questions or to register your product, visit us online at sharkclean.com

