

***Shark* VACMOP™**

Cordless Hard Floor System

VM200 Series

OWNER'S GUIDE



IMPORTANT SAFETY INSTRUCTIONS

PLEASE READ ALL INSTRUCTIONS BEFORE USING THIS PRODUCT.

If the charging cord plug does not fit fully into the outlet, reverse the plug. If it still does not fit, contact a qualified electrician. DO NOT force into outlet or try to modify to fit.

⚠ WARNING

To reduce the risk of fire, electric shock, injury, or property damage:

When using an electrical appliance, basic precautions should always be followed, including the following:

THIS PRODUCT CONTAINS ELECTRICAL CONNECTIONS:

1. Use only as described in this manual. **DO NOT** use the VACMOP™ for any purpose other than those described in this manual.
2. These components contain electrical connections, electrical wiring, and moving parts that potentially present risk to the user.
3. Before each use, carefully inspect all parts for any damage. If a part is damaged, discontinue use.
4. Use only identical replacement parts.
5. This VACMOP contains no serviceable parts.
6. **DO NOT** immerse or spray water on the body of the VACMOP. To clean the surface, wipe with a dry cloth.
7. Keep the appliance and its charging cord out of reach of children. **DO NOT** allow the appliance to be used by children. Do not allow to be used as a toy. Close supervision is necessary when used near children.

GENERAL USE

8. This appliance can be used by persons with reduced physical, sensory or mental capabilities or lack of experience and knowledge if they have been given supervision or instruction concerning use of the appliance in a safe way and understand the hazards involved. Cleaning and user maintenance shall not be made by children. Always turn off the VACMOP before connecting or disconnecting any current carrying hoses, chargers, batteries, or other electrical or mechanical parts.
9. **DO NOT** handle plug or VACMOP with wet hands.
10. **DO NOT** use without VACMOP disposable pad attached.
11. Only use Shark® branded VACMOP disposable pads.
12. **DO NOT** put any objects into VACMOP base. **DO NOT** use with any opening blocked; keep free of dust, lint, hair, and anything that may reduce airflow.
13. **DO NOT** use if VACMOP base airflow is restricted. If the air paths or the VACMOP base become blocked, turn the VACMOP off. Remove all obstructions before you turn on the unit again.
14. Keep all VACMOP base openings away from hair, face, fingers, uncovered feet, or loose clothing.
15. **DO NOT** use if VACMOP is not working as it should, or has been dropped, damaged, left outdoors, or dropped into water.
16. Use extra care when cleaning on stairs.
17. **DO NOT** place VACMOP on unstable surfaces such as chairs or tables.

18. DO NOT use to pick up:

- a) Large quantities of dust (including drywall, fireplace ash, or embers).
- b) Smoking or burning objects (hot coals, cigarette butts, or matches)
- c) Flammable or combustible materials (lighter fluid, gasoline, or kerosene)
- d) Toxic materials (chlorine bleach, ammonia, or drain cleaner)

19. DO NOT use in the following areas:

- a) Poorly lit areas
- b) Outdoor areas
- c) Spaces that are enclosed and may contain explosive or toxic fumes or vapors (lighter fluid, gasoline, kerosene, paint, paint thinners, mothproofing substances, or flammable dust)

20. Release all operational triggers on the VACMOP before plugging in or unplugging the charger.

21. Release all operational triggers on the VACMOP before any adjustment, cleaning, maintenance or troubleshooting.

22. DO NOT modify or attempt to repair the VACMOP or the battery yourself, except as indicated in this manual. DO NOT use the battery or VACMOP if it has been modified or damaged. Damaged or modified batteries may exhibit unpredictable behavior resulting in fire, explosion or risk of injury.

23. Always release all operational triggers on this appliance before attaching or detaching a VACMOP disposable pad.

BATTERY

24. The battery is the power source for the VACMOP. Carefully read and follow all charging instructions.

25. To prevent unintentional starting, DO NOT carry the appliance with your finger on the trigger or spray button.

26. Use only Shark® standard replacement charger. Use of an incorrect charger may result in no charging, and/or unsafe conditions. A charger that is suitable for one type of battery may create a risk of fire when used with another battery.

27. Keep the battery away from all metal objects such as paper clips, coins, keys, nails, or screws. Shorting the battery terminals increases the risk of fire or burns.

28. Under abusive conditions, liquid may be ejected from the battery. Avoid contact with this liquid, as it may cause irritation or burns. If contact occurs, flush with water. If liquid contacts eyes, seek medical help.

29. Battery should not be stored at temperatures below 37.4°F (3°C) or above 104°F (40°C) to maintain long-term battery life.

30. DO NOT charge battery at temperatures below 40°F (5°C) or above 104°F (40°C). Charging improperly or at temperatures outside of the specified range may damage the battery and increase the risk of fire.

31. Store the appliance indoors. DO NOT use or store it below 37.4°F (3°C). Ensure the appliance is at room temperature before operating.

32. DO NOT expose the battery to fire or temperatures above 265°F (130°C) as it may cause explosion.

33. Not for wet pickup.

34. Use only Shark brand cleaning fluids.

SAVE THESE INSTRUCTIONS

ASSEMBLY

Your VACMOP™ unit comes partially assembled with a cord connecting the parts. All versions assemble the same way. This appliance is for Household use only.

1. Align and insert the **Handle** into the top of the **Pole**. You will feel it click in place.
2. Align and insert the pole into the **Main Body**. You will feel it click in place.

For proper operation, ensure all components are completely connected and clicked into place.

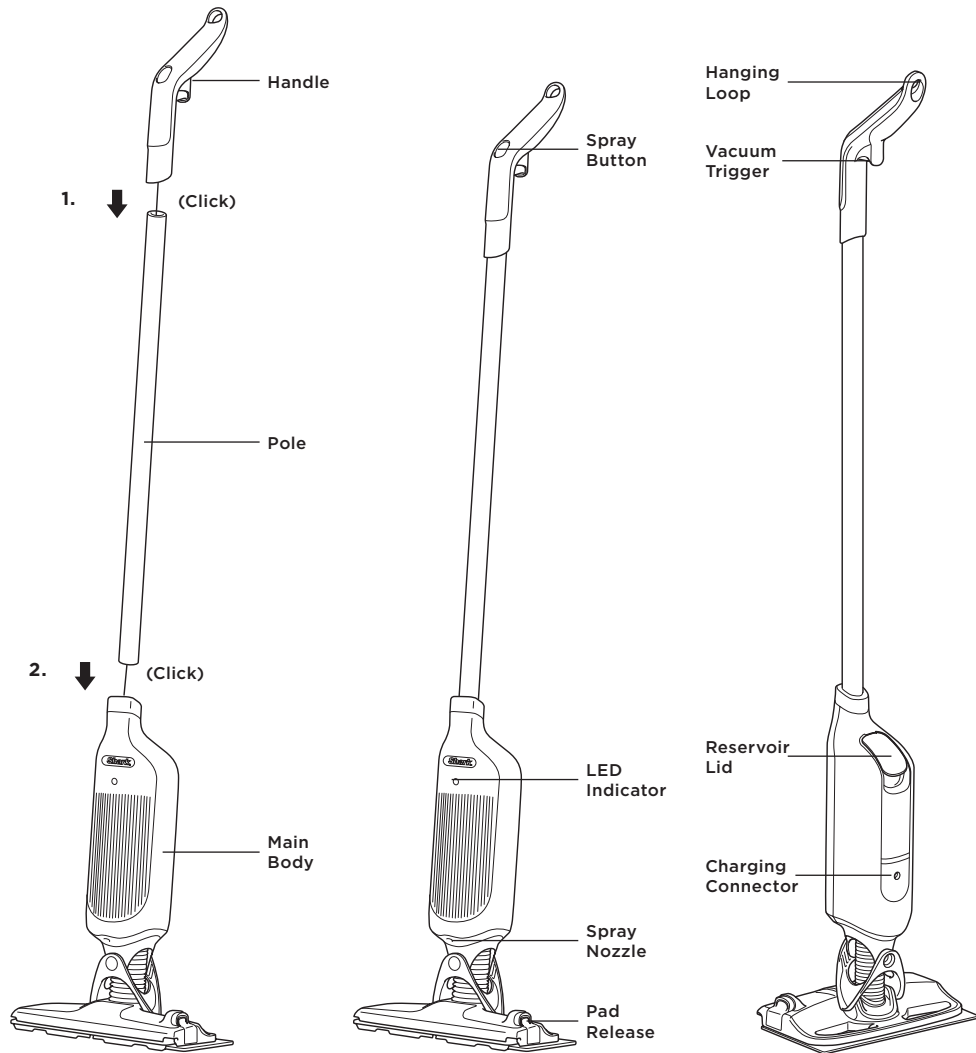

NOTE: The model and serial numbers can be found on the QR code label on the back on the main body.

CONTROLS

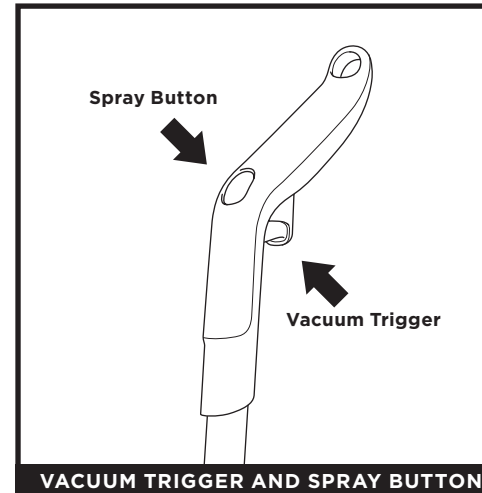

Spray Button

Press and hold the spray button on top of the handle to dispense cleaning solution through the spray nozzle.

Vacuum Trigger

To vacuum, pull the trigger and hold it in.

ATTACHING AND REMOVING PADS

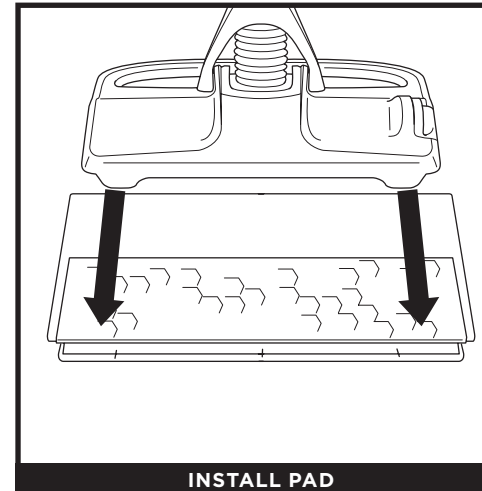

Place the VACMOP™ Disposable Pad on the floor with the dust chamber up. Line up the front edge of the VACMOP into the plastic bumper on the pad. Holding the handle, press the VACMOP base down until the pad clicks into place.



Dispose of dirty pads by releasing them directly into the trash. To detach the pad, press the release button on the side of the VACMOP base.

CHARGING THE LI-ION BATTERY

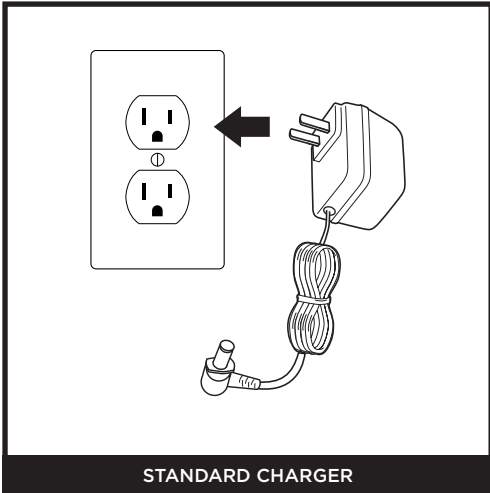

STANDARD CHARGER

Plug charger into an electrical outlet.

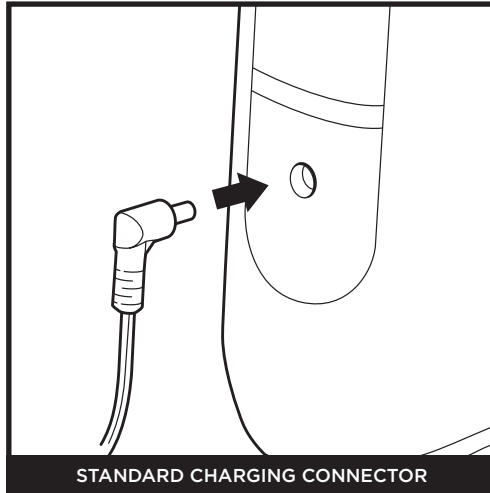

STANDARD CHARGING CONNECTOR

Plug the charger into the port on the back of the main body.

LI-ION BATTERY

Prior to first use, charge completely. A full charge takes approximately 3.5 hours.

BATTERY RUNTIME

Visit sharkclean.com/support online.

LED BATTERY POWER AND CHARGING INDICATOR

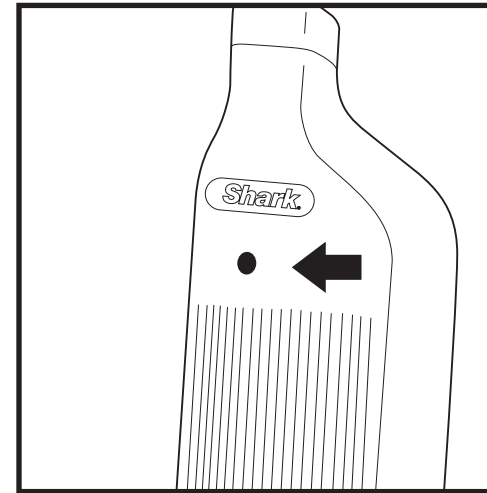

Indicator LED

IN USE:

Normal Operation - Solid green

Low Battery - Blinking green

Very Low Battery - Blinking red

Out of battery - Rapid blinking red

CHARGING:

Battery Charging - Pulsing green

Full Charge - Solid Green
(will turn off after 5 minutes)

RECYCLING THE LI-ION BATTERY

When the Shark® Li-Ion battery needs to be replaced, dispose of it or recycle it in accordance with local ordinances or regulations. In some areas, it is illegal to place spent lithium-ion batteries in the trash or in a municipal solid waste stream. Return spent batteries to an authorized recycling center or to the retailer for recycling. Contact your local recycling center for information on where to drop off the spent battery.

NOTE: The Shark battery, like all lithium-ion batteries, will naturally decrease in capacity over time from the 100% capacity of a new battery.

FILLING THE RESERVOIR

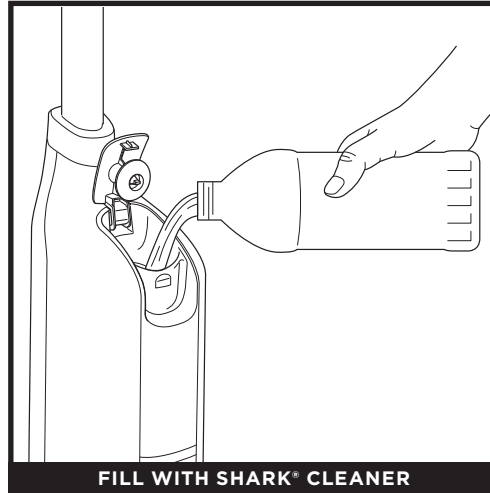
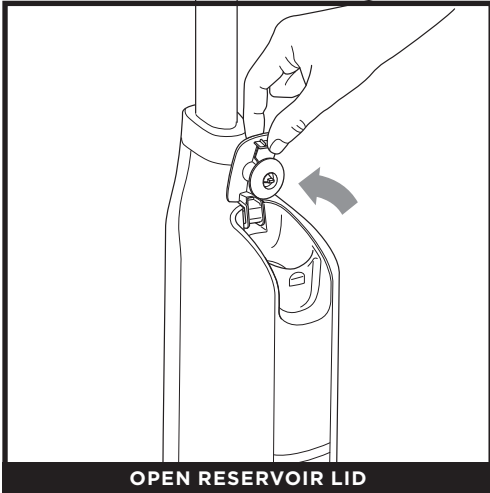

Lift the reservoir lid and press it up until it clicks into the open locked position. Carefully pour Shark Cleaner into the reservoir, up to the **MAX** line. When finished, press the lid closed.

NOTE: Before using your unit for the first time, carefully add the entire starter bottle of Shark Cleaner into the reservoir.

CLEANING MODES

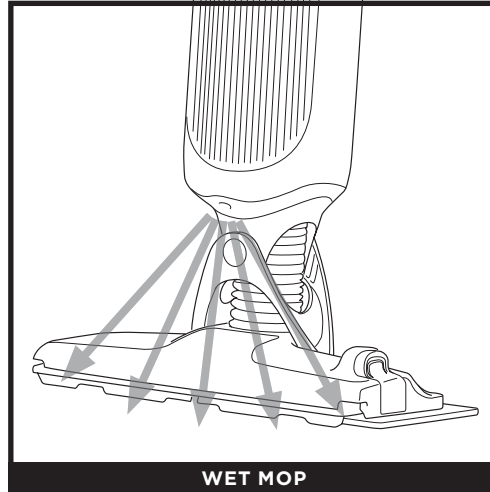
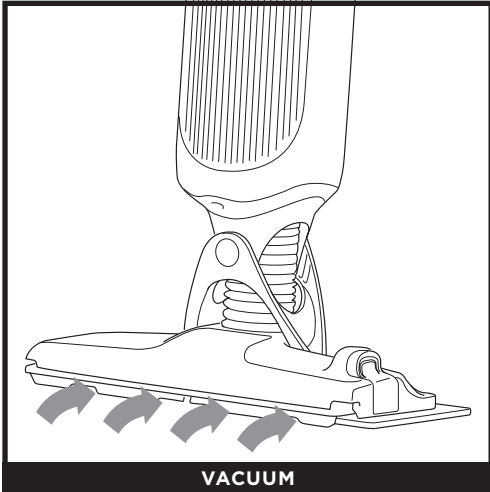

For best results, first use the vacuum to remove debris, then spray the Shark Cleaner to wet mop.

STORAGE

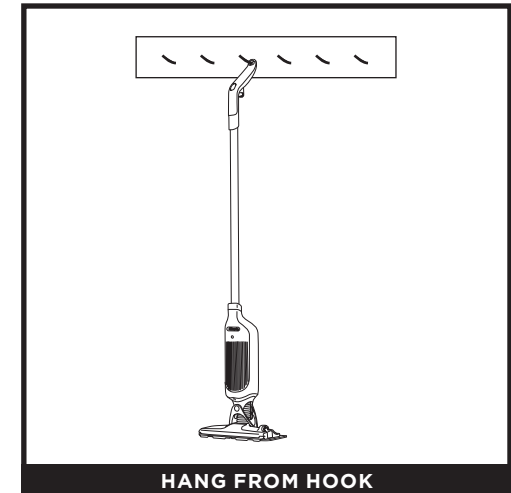
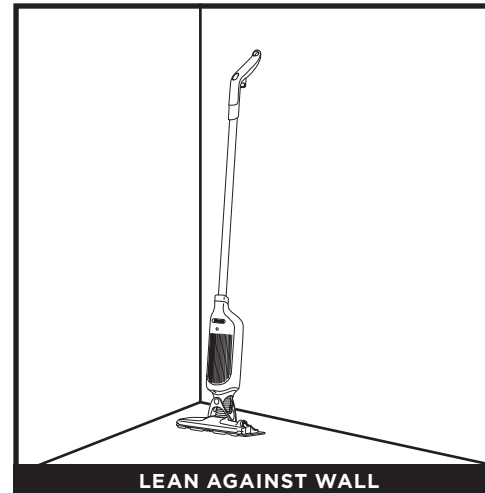

After wet cleaning, remove the pad from the VACMOP™ base before storing the unit.

To store the unit, stand it upright and lean the back of the non-slip handle against a wall.

To hang the unit from a nail or wall hook (not included) align the opening at the end of the handle over the hook or nail.

MAINTAINING YOUR VACUUM

TROUBLESHOOTING

VACMOP™ is not picking up debris. No suction or light suction.

- VACMOP Disposable Pad may not be securely attached. Reattach the pad.
- VACMOP Disposable Pad may be full of debris and need to be replaced.
- Battery charge may be low. Recharge the battery completely.

The unit turns off on its own. Sprayer is not spraying.

- Battery charge may be low. Recharge the battery completely.

Streaks appear on floor after wet mopping.

- VACMOP Multi-Surface Cleaner is designed to deliver a streak-free finish when used with the Shark VACMOP. Using other cleaner may result in streaking and residue.

FREQUENTLY ASKED QUESTIONS

When should I replace my VACMOP Disposable Pad?

- Replace the pad when it becomes fully saturated, its dust bin is full, it is noticeably dirty, or if the VACMOP is showing signs of reduced suction power.

Where can I use my VACMOP?

- VACMOP can safely be used on all sealed hard floors—stone, hardwood, vinyl, laminate, tile, marble, and linoleum.

ADDITIONAL ACCESSORIES AVAILABLE ON SHARKCLEAN.COM/VACMOP

WHAT'S INCLUDED

- Ⓐ VACMOP™ Disposable Pads
- Ⓑ VACMOP Cleaner
- Ⓒ Standard Replacement Charger

A

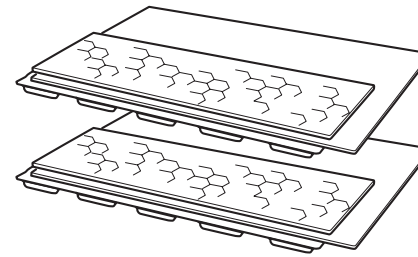

B

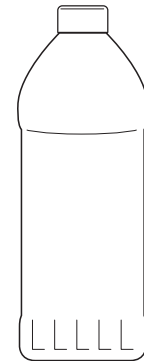

C

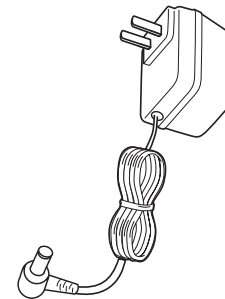

NOTE: Not all accessories come with all units. For a list of the accessories included with this model, see the top inside flap of the box. To order additional accessories, visit sharkaccessories.com.

ONE (1) YEAR LIMITED WARRANTY

The One (1) Year Limited Warranty applies to purchases made from authorized retailers of **SharkNinja Operating LLC**. Warranty coverage applies to the original owner and to the original product only and is not transferable.

SharkNinja warrants that the unit shall be free from defects in material and workmanship for a period of one (1) year from the date of purchase when it is used under normal household conditions and maintained according to the requirements outlined in the Owner's Guide, subject to the following conditions and exclusions:

What is covered by this warranty?

1. The original unit and/or non-wearable parts deemed defective, in SharkNinja's sole discretion, will be repaired or replaced up to one (1) year from the original purchase date.
2. In the event a replacement unit is issued, the warranty coverage ends six (6) months following the receipt date of the replacement unit or the remainder of the existing warranty, whichever is later. SharkNinja reserves the right to replace the unit with one of equal or greater value.

What is not covered by this warranty?

1. Normal wear and tear of wearable parts (such as Shark Cleaner, Pad, etc.), which require regular maintenance and/or replacement to ensure the proper functioning of your unit, are not covered by this warranty. Replacement parts are available for purchase at sharkaccessories.com.
2. Any unit that has been tampered with or used for commercial purposes.
3. Damage caused by misuse (e.g., vacuuming up water or other liquids), abuse, negligent handling, failure to perform required maintenance, or damage due to mishandling in transit.
4. Consequential and incidental damages.
5. Defects caused by repair persons not authorized by SharkNinja. These defects include damages caused in the process of shipping, altering, or repairing the SharkNinja product (or any of its parts) when the repair is performed by a repair person not authorized by SharkNinja.
6. Products purchased, used, or operated outside North America.

How to get service

If your appliance fails to operate properly while in use under normal household conditions within the warranty period, visit sharkclean.com/support for product care and maintenance self-help. Our Customer Service Specialists are also available at **1-800-798-7398** to assist with product support and warranty service options, including the possibility of upgrading to our VIP warranty service options for select product categories. So we may better assist you, please register your product online at registryyourshark.com and have the product on hand when you call.

SharkNinja will cover the cost for the customer to send in the unit to us for repair or replacement. A fee of \$24.95 (subject to change) will be charged when SharkNinja ships the repaired or replacement unit.

How to initiate a warranty claim

You must call **1-800-798-7398** to initiate a warranty claim. You will need the receipt as proof of purchase. We also ask that you register your product online at registryyourshark.com and have the product on hand when you call, so we may better assist you. A Customer Service Specialist will provide you with return and packing instruction information.

How state law applies

This warranty gives you specific legal rights, and you also may have other rights that vary from state to state. Some states do not permit the exclusion or limitation of incidental or consequential damages, so the above may not apply to you.

ONE (1) YEAR LIMITED BATTERY WARRANTY

The One (1) Year Limited Warranty applies to purchases made from authorized retailers of **SharkNinja Operating LLC**. Warranty coverage applies to the original owner and to the original product only and is not transferable.

SharkNinja warrants that the unit shall be free from defects in material and workmanship for a period of one (1) year from the date of purchase when it is used under normal household conditions and maintained according to the requirements outlined in the Owner's Guide, subject to the following conditions and exclusions:

What is covered by this warranty?

1. The original battery deemed defective, in SharkNinja's sole discretion, will be replaced up to one (1) year from the original purchase date.
2. In the event a replacement battery is issued, the warranty coverage ends six (6) months following the receipt date of the replacement battery or the remainder of the existing warranty, whichever is later. SharkNinja reserves the right to replace the unit with one of equal or greater value.

What is not covered by this warranty?

1. Normal wear and tear of the battery, which requires optimal temperature storage and operation to ensure its proper functioning.
2. A battery that has been tampered with or used for commercial purposes.
3. Damage caused by misuse (e.g., exposing battery to liquids or extreme hot and/or cold temperatures), abuse, negligent handling, failure to perform required maintenance, or damage due to mishandling in transit.
4. Consequential and incidental damages.
5. Defects caused by repair persons not authorized by SharkNinja. These defects include damages caused in the process of shipping, altering, or repairing the SharkNinja product (or any of its parts) when the repair is performed by a repair person not authorized by SharkNinja.
6. Products purchased, used, or operated outside North America.

How to get service

If your battery fails to operate properly while in use under normal household conditions within the warranty period, visit sharkclean.com/support for product care and maintenance self-help. Our Customer Service Specialists are also available at **1-800-798-7398** to assist with product support and warranty service options. So we may better assist you, please register your product online at registryyourshark.com and have the product on hand when you call.

SharkNinja will cover the cost for the customer to send in the unit to us for replacement. A fee of \$19.95 (subject to change) will be charged when SharkNinja ships the replacement unit.

How to initiate a warranty claim

You must call **1-800-798-7398** to initiate a warranty claim. You will need the receipt as proof of purchase. We also ask that you register your product online at registryyourshark.com and have the product on hand when you call, so we may better assist you. A Customer Service Specialist will provide you with return and packing instruction information when you call. A Customer Service Specialist will provide you with return and packing instruction information.

How state law applies

This warranty gives you specific legal rights, and you also may have other rights that vary from state to state. Some states do not permit the exclusion or limitation of incidental or consequential damages, so the above may not apply to you.

REGISTER YOUR PURCHASE

 registeryourshark.com

RECORD THIS INFORMATION

Model Number: _____

Date Code: _____

Date of Purchase: _____
(Keep receipt)

Store of Purchase: _____

TIP: The model and serial numbers are on the QR code label on the back of the main body.

TECHNICAL SPECIFICATIONS

Voltage: 10.8V 

Watts: 85W

Amps: 7.8A

PLEASE READ CAREFULLY AND KEEP FOR FUTURE REFERENCE.

This Owner's Guide is designed to help you keep your VACMOP™ running at peak performance.

BATTERY REMOVAL AND DISPOSAL

This product uses a lithium-ion rechargeable and recyclable battery. When the battery no longer holds a charge, it should be removed from the VACMOP and recycled. DO NOT incinerate or compost the battery.

When your lithium-ion battery needs to be replaced, dispose of it or recycle it in accordance with local ordinances or regulations. In some areas, it is illegal to place spent lithium-ion batteries in the trash or in a municipal solid waste stream. Return spent battery to an authorized recycling center or to retailer for recycling. Contact your local recycling center for information on where to drop off the spent battery.

The RBRC™ (Rechargeable Battery Recycling Corporation) seal on the lithium-ion battery indicates that the costs to recycle the battery at the end of its useful life have already been paid by SharkNinja. In some areas, it is illegal to place spent lithium-ion batteries in the trash or municipal solid waste stream and the RBRC program provides an environmentally conscious alternative.

RBRC, in cooperation with SharkNinja and other battery users, has established programs in the United States and Canada to facilitate the collection of spent lithium-ion batteries. Help protect our environment and conserve natural resources by returning the spent lithium-ion battery to an authorized SharkNinja service center or to your local retailer for recycling. You may also contact your local recycling center for information on where to drop off the spent battery, or call 1-800-798-7398.



PLEASE READ CAREFULLY AND KEEP FOR FUTURE REFERENCE.

This Owner's Guide is designed to help you get a complete understanding of your new Shark® VACMOP™ cordless hard floor system.

SharkNinja Operating LLC
US: Needham, MA 02494
CAN: Ville St-Laurent, QC H4S 1A7
1-800-798-7398
sharkclean.com

Illustrations may differ from actual product. We are constantly striving to improve our products, therefore the specifications contained herein are subject to change without notice.

For SharkNinja U.S. patent information, visit sharkninja.com/uspatents/

© 2020 SharkNinja Operating LLC. SHARK is a registered trademark of SharkNinja Operating LLC.

VACMOP is a trademark of SharkNinja Operating LLC.

RBRC is a trademark of Rechargeable Battery Recycling Corporation.

VM200Series_IB_REV_Mv7

PRINTED IN CHINA



@sharkcleaning