

Shark®

Pro Steam Pocket® Mop

SE450
Series

OWNER'S GUIDE



@sharkcleaning

IMPORTANT SAFETY INSTRUCTIONS

For Household Use Only

WHEN USING YOUR SHARK® STEAM MOP, BASIC SAFETY PRECAUTIONS SHOULD ALWAYS BE FOLLOWED, INCLUDING THE FOLLOWING:

READ ALL INSTRUCTIONS BEFORE USING YOUR STEAM MOP.

 **WARNING: DANGER OF SCALDING.**
The steam emitted from the Steam Mop is very hot and may cause scalding. Please use caution when using the Steam Mop.

 **WARNING: KEEP STEAM MOP AWAY FROM CHILDREN.**

POLARIZED PLUG:

This Steam Mop has a polarized plug (one blade is wider than the other). As a safety feature, this plug will fit into a polarized outlet only one way. If the plug does not fit fully into the outlet, reverse the plug. If it still does not fit, contact a qualified electrician. **DO NOT attempt to defeat this safety feature.**

 **WARNING:**
TO REDUCE THE RISK OF FIRE, ELECTRIC SHOCK OR INJURY:

-  **CAUTION: When in use, NEVER turn the Steam Mop over or on its side. NEVER direct steam toward people, pets, or plants.**
- Use the system only for its intended use.
- DO NOT** use outdoors.
- DO NOT** use for space-heating purposes.
- DO NOT** leave the appliance unattended when plugged in. **ALWAYS** unplug the power cord from the electrical outlet when not in use and before servicing.
- DO NOT** allow the appliance to be used by children. Close attention is necessary when used near children, pets, or plants.
- Use only as described in this manual.
- Use only manufacturer's recommended accessories.
- DO NOT** use with damaged cord or plug. If Steam Mop is not working as it should or has been dropped, damaged, left outdoors, or dropped into water, return it to SharkNinja Operating LLC for examination and repair. Incorrect reassembly or repair can cause a risk of electrical shock or injury.
- To protect against a risk of electric shock, **DO NOT** immerse the Steam Mop into water or any other liquids.
- DO NOT** handle plug or Steam Mop with wet hands or operate appliance without shoes.
- DO NOT** pull or carry by power cord, use power cord as handle, close a door on the power cord, or pull the power cord around sharp edges or corners. Keep power cord away from heated surfaces.
- DO NOT** unplug by pulling on power cord. To unplug, grasp the plug not the power cord. **DO NOT** use extension cords or outlets with inadequate current carrying capacity.

14. **DO NOT** put any objects into openings. **DO NOT** use with any opening that is blocked.
15. **DO NOT** put hands or feet under the Steam Mop. Unit gets very hot.
16. Use **ONLY** on flat, horizontal surfaces. **DO NOT** use on walls, counters or windows.
17. **DO NOT** use on leather, wax polished furniture or floors, synthetic fabrics, velvet or other delicate, steam sensitive materials.
18. **DO NOT** add cleaning solutions, scented perfumes, oils or any other chemicals to the water used in this appliance as this may damage the unit or make it unsafe for use. If you live in a hard water area, we recommend using distilled water in your Steam Mop.
19. **NEVER** leave any pocket pad in one spot while using or storing for an extended period, as this may damage your surfaces.
20. Carefully remove the pocket pad immediately after you have unplugged and allowed the Steam Mop to cool.
21. When cleaning the Steam Mop, unplug the power cord from the electrical outlet and clean with a dry or damp cloth. **DO NOT** pour water or use alcohol, benzene or paint thinner on the unit.
22. Extreme caution should be exercised when using this appliance to clean stairs.
23. **NEVER** use the Steam Mop without the pocket pad attached.
24. Keep your work area well lit.
25. Store the Steam Mop indoors in a cool, dry place.
26. To avoid circuit overload, **DO NOT** operate another appliance on the same socket (circuit) as the steam cleaner.
27. **DO NOT** leave your Steam Mop unattended when it is connected to a power supply/electrical outlet.
28. **ALWAYS** unplug and allow the Steam Mop to cool before removing, changing, or servicing mop heads.

CAUTION:

Your Steam Pocket Mop is designed to clean hard floor surfaces that will withstand high heat. DO NOT use on unsealed wood or unglazed ceramic floors. On surfaces that have been treated with wax or some unwaxed floors, the sheen may be removed by the heat and steam action. Test an isolated area of the surface to be cleaned before proceeding, and follow the use and care instructions from the floor manufacturer.

SAVE THESE INSTRUCTIONS

THANK YOU

for purchasing the Shark® Pro Steam Pocket® Mop.



TIP: You can find the model and serial numbers on the QR code label which is located on the back of the unit by the power cord.

REGISTER YOUR PURCHASE



registryyourshark.com



Scan QR code using mobile device

RECORD THIS INFORMATION

Model Number: _____

Serial Number: _____

Date of Purchase: _____
(Keep receipt)

Store of Purchase: _____

PLEASE READ CAREFULLY AND KEEP FOR FUTURE REFERENCE.

These instructions are designed to help you get a complete understanding of your new Shark Pro Steam Pocket Mop.

If you have any questions, please visit sharkclean.com or call Customer Service line at 1-800-798-7398.

THIS MANUAL COVERS MODEL NUMBERS SE450 N3

TECHNICAL SPECIFICATIONS

Voltage: 120V., 60Hz.

Power: 1200 Watts

Water Capacity: 500ml (16.9 oz.)

CONTENTS

Getting Started	6
Using Your Steam Mop	9
Care of Your Steam Mop	13
Troubleshooting Guide	15
Accessories.....	16
Warranty.....	19

GETTING STARTED

When assembling your Steam Mop there may be a little water in or around the water tank. This is because we test all our Steam Mops before you buy them, so you get a quality Shark® Pro Steam Pocket® Mop.

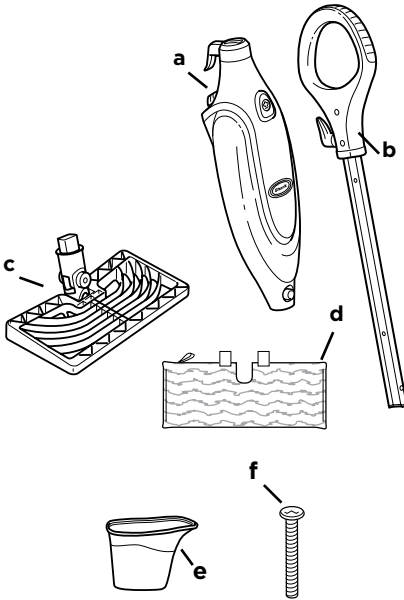

- a** Steam Mop Body
- b** Mop Handle
- c** 2 Rectangle Mop Heads included
- d** Dirt Grip® pocket pad
- e** Filling Flask
- f** (1) 6mm x 54mm Large Screw*

*Phillips-head or flat-head screwdriver can be used. Screwdriver not included.

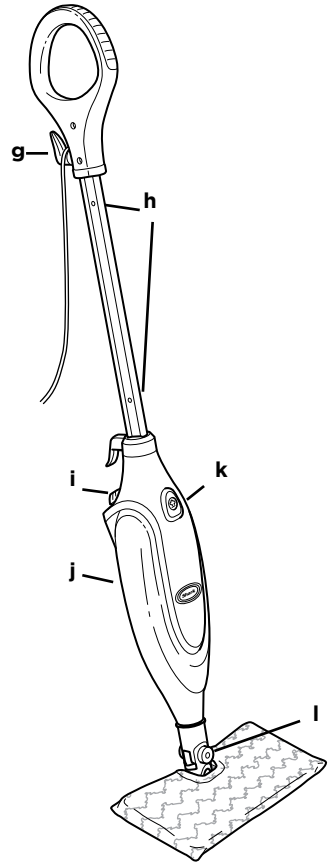

- g** Quick Release Cord Holder
- h** Cord Clips
- i** Water Tank Cap
- j** Water Tank
- k** Steam Control Button
- l** Mop Head Release Button

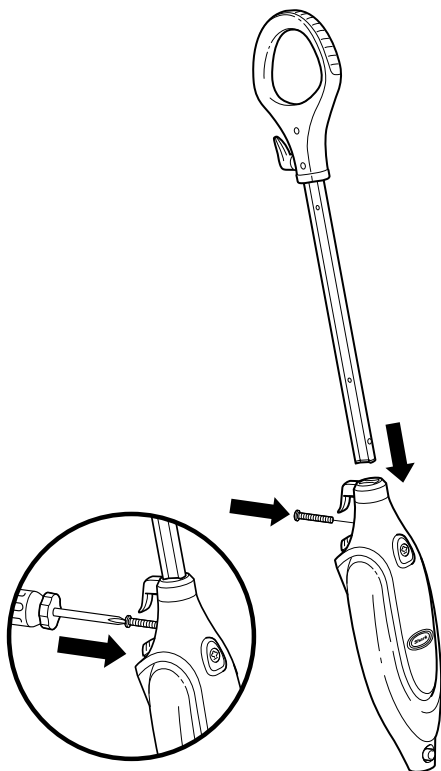

fig. 1

IMPORTANT: ALWAYS make sure the Shark® Pro Steam Pocket® Mop is **UNPLUGGED** from the wall when not in use. **NEVER** fill the mop, attach the mop head, or change or remove the pocket pad when the mop is plugged into the wall. To prolong the life of your Steam Mop, we recommend using distilled water. Make sure you only add water to the tank. Chemicals or cleaning solution may damage the appliance and could be unsafe for you and your family.

ASSEMBLE

- 1 Insert the mop handle into the Steam Mop body. Be sure the cord hook is facing the back of the mop and the handle is inserted past the line marked on the pole. Secure handle in place with the included screw and either a Phillips-head or flat-head screwdriver (not included). **(fig. 1)**

GETTING STARTED - CONT'D

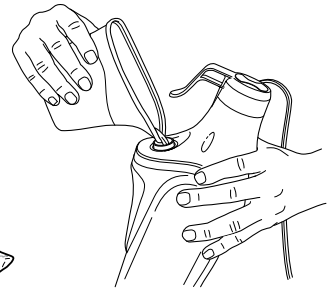
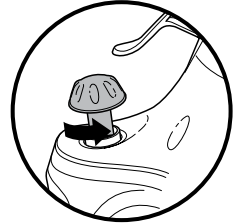
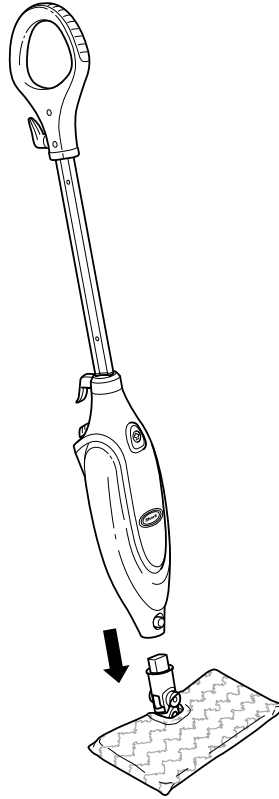
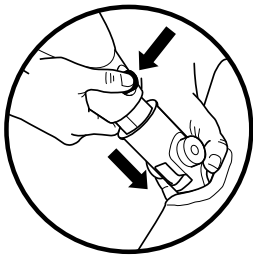
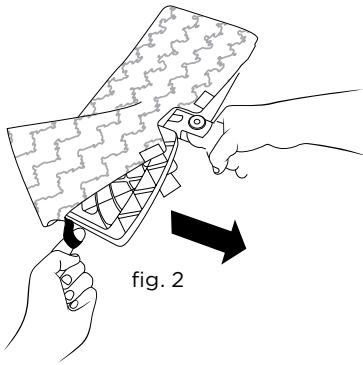

- 2 Use the lavender loop on the side of the pocket pad to slide mop head into pocket. Then secure the quick fasteners on the top of the pocket to lock in place. **(fig. 2)**
- 3 Insert the mop head post into the mop body until it clicks into place. **(fig. 3)**
- 4 Twist the cap on the water tank counterclockwise to open. **(fig. 4)** Use the filling flask to pour water into the tank. **DO NOT** overfill. Replace the cap on the water tank and turn it clockwise to secure it. **(fig. 5)**

IMPORTANT: DO NOT use Steam Mop on unsealed wood or unglazed ceramic floors. On surfaces that have been treated with wax or some unwaxed floors, the sheen may be removed by the heat and steam action. Test an isolated area of the surface to be cleaned before proceeding, and follow the use and care instructions from the floor manufacturer.

NOTE: To prolong the life of your Steam Mop, we recommend using distilled water.

USING YOUR STEAM MOP

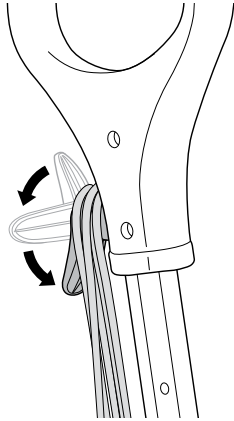

fig. 6

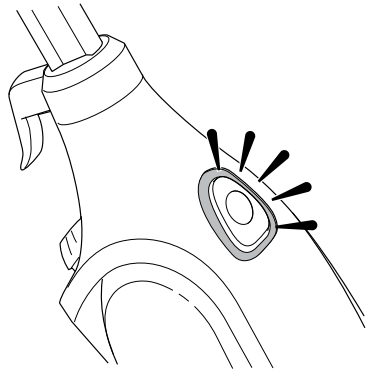

fig. 7

IMPORTANT: NEVER use the Steam Mop unless there is water in the tank and a pocket pad is attached.

Sweep or vacuum your floors prior to cleaning with your Steam Mop.

Visit sharkaccessories.com for other great cleaning products.

- 1** Pull and twist the quick release cord holder to unwrap the power cord completely. Plug into an electrical outlet. **(fig. 6)**
- 2** When cord is plugged in, the Steam Control button will flash blue. If the light does not illuminate, reference the Troubleshooting section. **(fig. 7)**

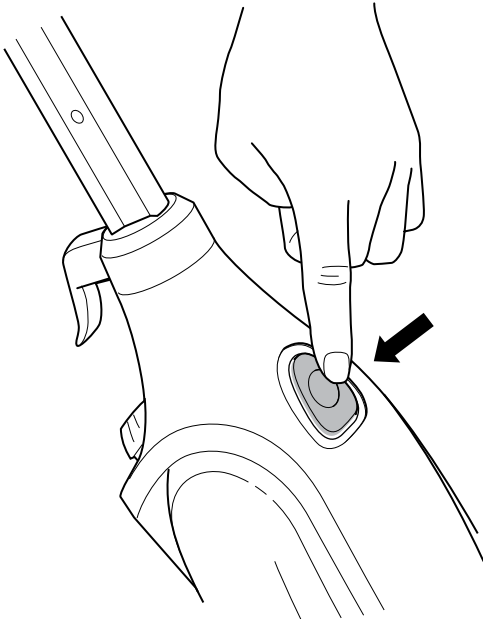

fig. 8

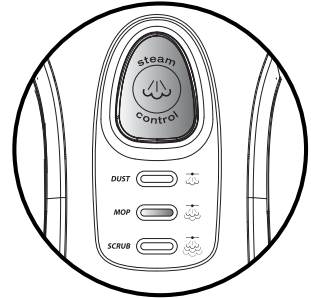

fig. 9

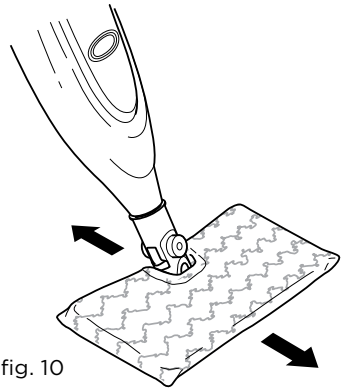

fig. 10

SELECTING A STEAM SETTING

- 3** For quick dusting and drying, use the DUST setting. Press the steam control button once to select DUST. **(fig. 8)** For normal everyday steam cleaning, press the steam control button again to select the MOP setting. **(fig. 9)**

When you are using the mop for the first time, it might take longer than the normal 30 seconds to start steaming.

To better understand which steam setting to use for each cleaning task, refer to the Settings chart on page 11.

- 4** Clean your floors with a forward and backward motion. **(fig. 10)** To stop the steam, press the steam control button until it flashes.

The Shark® Pro Steam Pocket® Mop has two unique steam settings so you can use the perfect amount of steam for the cleaning task at hand. See below for tips on when to use each setting.

SETTINGS	IDEAL FOR THESE SURFACES	RECOMMENDED USAGE
DUST 	Laminate Bamboo Hardwood Marble	Light cleaning and dusting Loosening and removing light dirt
MOP 	Hardwood Marble Tile Stone Linoleum	Basic, everyday steam cleaning Removing spots and smaller messes Cleaning moderately or heavily trafficked areas Sanitizing floors*

TO SANITIZE* WITH THE RECTANGLE MOP HEAD:

- 1 Start with a clean pad.
- 2 Follow instructions in the Using Your Steam Mop section.
- 3 Wait for the unit to begin producing steam.
- 4 Start mopping on an appropriate sealed hard-floor surface with a forward and backward motion.
- 5 After three minutes, your unit will be ready to sanitize.
- 6 Using a forward and backward motion, move the unit slowly and evenly over the area to be sanitized.
- 7 Repeat at least 15 times.

*Sanitization studies were conducted under controlled test conditions. Household conditions and results may vary.

IMPORTANT: DO NOT use the Steam Mop without attaching a Dirt Grip® pad and adding water to the water tank first. When you are using the Steam Mop for the first time, it might take longer than the normal 30 seconds to start steaming.

IMPORTANT: DO NOT use on unsealed wood or unglazed ceramic floors. On surfaces that have been treated with wax and on some unwaxed floors, the sheen may be removed by the heat and steam action. Test an isolated area of the surface to be cleaned before proceeding, and follow the use and care instructions from the floor manufacturer.

USING YOUR STEAM MOP - CONT'D

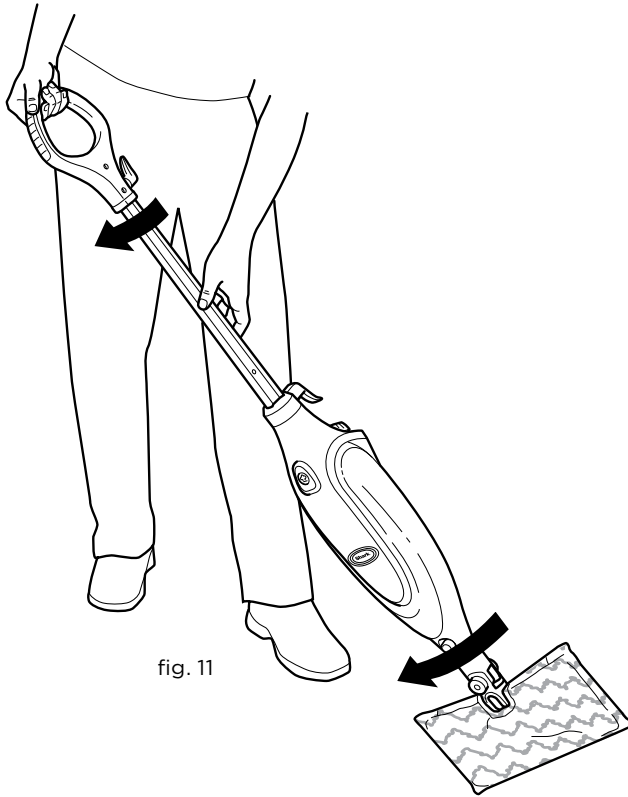

fig. 11

5 When one side of the pocket pad gets dirty, just flip the mop head over to use the other side. **ALWAYS** unplug the Steam Mop before changing or removing pads. **(fig. 11)**

6 When the water tank is empty, the Steam Mop will stop producing steam. To refill the tank, first unplug the Steam Mop, then use the filling flask to refill the water tank.

NOTE: Please wait 2 to 3 minutes for the Steam Mop to cool off before removing the mop head or the pocket pad. **NEVER** leave the Steam Mop with a damp or wet pad attached.

CARE OF YOUR STEAM MOP

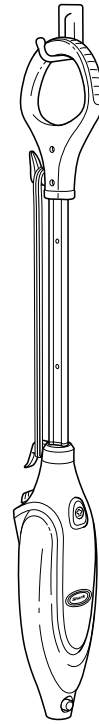
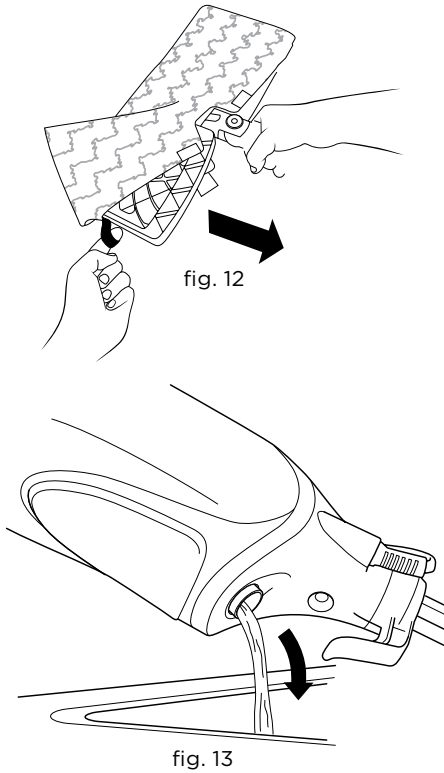

AFTER USE AND STORAGE

- 1** When you have finished using the Steam Mop, stop the steam by pressing and holding the steam control button until the light flashes blue. Unplug from the outlet, stand the mop upright, and let it cool for 2 to 3 minutes.
Release the pocket pad from the mop head. **(fig. 12)**
- 2** All water must be removed from the tank before storage. Remove the cap and pour the remaining water out of the tank into a sink. Replace the cap on the water tank. **(fig. 13)**
- 3** After the unit has cooled and all steam has been released, remove the mop head. Store the Steam Mop by hanging it from a large hook on the wall. (Hook not included.). **(fig. 14)**

CARE OF YOUR STEAM MOP - CONT'D

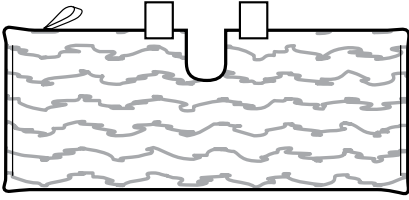

fig. 15

CARE OF THE DIRT GRIP® PAD

- 1 We recommend washing the pad separately from other fabrics to avoid picking up lint. Only use liquid detergent (no powder detergent). **DO NOT** use any fabric softeners or bleach. Line dry or dry on a low dryer setting. **(fig. 15)**
- 2 If there are loose threads on the pad, carefully cut the threads with scissors. **DO NOT** pull on them or cut at the base. **(fig. 16)**

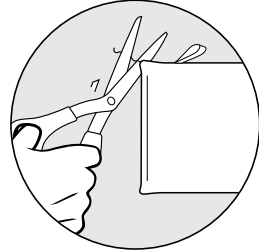

fig. 16

DECALCIFYING YOUR STEAM MOP

Over time, calcium and mineral deposits can build up and impact the performance of your Steam Mop. To extend the life of your product, we recommend that you use distilled water.

ORDERING REPLACEMENT PARTS

Replacement parts and accessories are available at sharkclean.com.

TROUBLESHOOTING GUIDE

PROBLEM	POSSIBLE REASONS & SOLUTIONS
<p>The Pro Steam Pocket® Mop will not turn on.</p>	<p>Make sure the Steam Mop is securely plugged in to a working electrical outlet. Check the fuse or breaker. If your unit still does not work, call Customer Service at 1-800-798-7398.</p>
<p>The unit will not make steam.</p>	<p>Is there water in the water tank? If not, add water, following the instructions on page 8. If you are using tap water, we recommend switching to distilled water.</p>
<p>Cannot select steam setting/flashing blue light remains on.</p>	<p>If you have already plugged in your unit, unplug and try a different outlet. This may reset the standby mode. Add water to the tank and press the steam control button to select a steam setting. If your unit still does not work, call Customer Service at 1-800-798-7398.</p>
<p>The Steam Mop leaves water on the floor.</p>	<p>Check to see if the pad is soaked through. We recommend unplugging the Steam Mop and changing the pad. Make sure the pocket pad is attached correctly.</p>
<p>The Steam Mop leaves white spots on the floor.</p>	<p>DO NOT leave your Steam Mop on the floor with a damp or wet pad attached. If you're using tap water, we recommend switching to distilled water. Make sure the cap is securely on the water tank.</p>
<p>Floors are cloudy, streaky, or spotty after steaming.</p>	<p>The pocket pad might be dirty. Flip or change the pocket pad. If you washed the pad with powder detergent, then it may be damaged and require replacement. Replacement pads are available at sharkaccessories.com. You might have left the mop in the same spot for too long. If you have hard water, try switching to distilled water. This residue may be left over from previous cleaners. Use the Steam Mop a few more times to remove the residue. If this does not work, we suggest rinsing the floor with water, letting it dry, and then steam mopping again with a clean pocket pad. One or more rinses generally removes the residue. A more stubborn case may require you to rinse the floor with a mix of one part vinegar and two parts water.</p>
<p>The Steam Mop is hard to push.</p>	<p>Make sure the pocket pad is attached correctly. Replace the pad if it is dirty.</p>

ACCESSORIES

NOTE: Not all accessories come with all units. For a list of the accessories included with this model, see the top inside flap of the box. To order additional accessories, visit sharkaccessories.com.

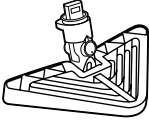
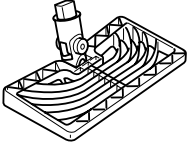
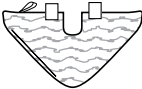
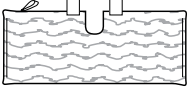
ACCESSORY	
<p>Triangle Mop Head Ideal for cleaning corners and other hard-to-reach areas.</p>	 A line drawing of a triangular mop head. It features a central cylindrical attachment point and a series of vertical ridges along its edges, designed for corner cleaning.
<p>Rectangle Mop Head For general, all-purpose steam cleaning.</p>	 A line drawing of a rectangular mop head. It has a central cylindrical attachment point and a series of curved, wavy ridges across its surface, intended for general-purpose cleaning.
<p>Triangle Steam Pocket® Dirt Grip® Washable Pad Double-sided triangle-shaped pad for cleaning corners and other hard-to-reach areas. Featuring Dirt Grip technology for removing moisture, dirt, and tough, stuck-on stains.</p>	 A line drawing of a triangular washable pad. It has a wavy, textured surface and two small rectangular tabs at the top edge for attachment to a mop head.
<p>Rectangle Steam Pocket Dirt Grip Washable Pad Double-sided for twice the cleaning capability of a single-sided pad. Dirt Grip technology combines a super-absorbent microfiber with a scrubbing material to remove moisture, dirt, and the toughest stains.</p>	 A line drawing of a rectangular washable pad. It features a wavy, textured surface and two small rectangular tabs at the top edge for attachment to a mop head.

ONE (1) YEAR LIMITED WARRANTY

The One (1) Year Limited Warranty applies to purchases made from authorized retailers of **SharkNinja Operating LLC**. Warranty coverage applies to the original owner and to the original product only and is not transferable.

SharkNinja warrants that the unit shall be free from defects in material and workmanship for a period of one (1) year from the date of purchase when it is used under normal household conditions and maintained according to the requirements outlined in the Owner's Guide, subject to the following conditions and exclusions:

What is covered by this warranty?

1. The original unit and/or non-wearable parts deemed defective, in SharkNinja's sole discretion, will be repaired or replaced up to one (1) year from the original purchase date.
2. In the event a replacement unit is issued, the warranty coverage ends six (6) months following the receipt date of the replacement unit or the remainder of the existing warranty, whichever is later. SharkNinja reserves the right to replace the unit with one of equal or greater value.

What is not covered by this warranty?

1. Normal wear and tear of wearable parts (such as foam filters, HEPA filters, pads, etc.), which require regular maintenance and/or replacement to ensure the proper functioning of your unit, are not covered by this warranty. Replacement parts are available for purchase at sharkaccessories.com.
2. Any unit that has been tampered with or used for commercial purposes.
3. Damage caused by misuse (e.g., vacuuming up water or other liquids), abuse, negligent handling, failure to perform required maintenance (e.g., not cleaning the filters), or damage due to mishandling in transit.
4. Consequential and incidental damages.
5. Defects caused by repair persons not authorized by SharkNinja. These defects include damages caused in the process of shipping, altering, or repairing the SharkNinja product (or any of its parts) when the repair is performed by a repair person not authorized by SharkNinja.
6. Products purchased, used, or operated outside North America.

How to get service

If your appliance fails to operate properly while in use under normal household conditions within the warranty period, visit sharkclean.com/support for product care and maintenance self-help. Our Customer Service Specialists are also available at **1-800-798-7398** to assist with product support and warranty service options, including the possibility of upgrading to our VIP warranty service options for select product categories. So we may better assist you, please register your product online at registryourshark.com and have the product on hand when you call.

SharkNinja will cover the cost for the customer to send in the unit to us for repair or replacement. A fee of \$24.95 (subject to change) will be charged when SharkNinja ships the repaired or replacement unit.

How to initiate a warranty claim

You must call **1-800-798-7398** to initiate a warranty claim. You will need the receipt as proof of purchase. We also ask that you register your product online at registryourshark.com and have the product on hand when you call, so we may better assist you. A Customer Service Specialist will provide you with return and packing instruction information.

How state law applies

This warranty gives you specific legal rights, and you also may have other rights that vary from state to state. Some states do not permit the exclusion or limitation of incidental or consequential damages, so the above may not apply to you.

PLEASE READ CAREFULLY AND KEEP FOR FUTURE REFERENCE.

This Owner's Guide is designed to help you get a complete understanding of your new Shark® Pro Steam Pocket® Mop.

SharkNinja Operating LLC
US: Needham, MA 02494
CAN: Ville St-Laurent, QC H4S 1A7
1-800-798-7398
sharkclean.com

Illustrations may differ from actual product. We are constantly striving to improve our products; therefore the specifications contained herein are subject to change without notice.

For SharkNinja U.S. Patent information, visit sharkninja.com/uspatents

Shark®

© 2020 SharkNinja Operating LLC. DIRT GRIP, SHARK, and STEAM POCKET are registered trademarks of SharkNinja Operating LLC.

PRINTED IN CHINA

SE450_SE460_IB_E_REV_Mv3