

# Owner's Guide

NV26



# **Shark**

[www.sharkclean.com](http://www.sharkclean.com)

## **TECHNICAL SPECIFICATIONS**

Voltage: 120V.

Watts: 1200W

Amps: 10A

Hertz: 60Hz



**TOLL FREE: 1-800-798-7398**

## Contents

Thank you for  
purchasing  
the Shark  
Navigator®  
Upright Vacuum.

<b>Important Safety Instructions</b>	2
<b>Getting Started</b>	4
<b>Using the Vacuum</b>	6
<b>Cleaning with the Vacuum Accessories</b>	7
<b>Emptying the Dust Cup Assembly</b>	8
<b>Proper Care of Your Vacuum</b>	9
<b>Troubleshooting</b>	10
<b>Checking for Blockages</b>	11
<b>Maintenance</b>	12
<b>Warranty and Registration</b>	13

# IMPORTANT SAFETY INSTRUCTIONS

## SAVE THESE INSTRUCTIONS

### For Household Use Only

**WHEN USING YOUR SHARK NAVIGATOR® UPRIGHT VACUUM, BASIC SAFETY PRECAUTIONS SHOULD ALWAYS BE FOLLOWED, INCLUDING THE FOLLOWING:**

**READ ALL INSTRUCTIONS BEFORE USING YOUR SHARK NAVIGATOR® UPRIGHT VACUUM.**

#### **POLARIZED PLUG:**

This appliance has a polarized plug (one blade is wider than the other). As a safety feature, this plug will fit into a polarized outlet only one way.

**Do not force into the outlet or try to modify the plug to fit.**

#### **⚠ WARNING:**

**TO REDUCE THE RISK OF ELECTRIC SHOCK OR INJURY DO NOT USE OUTDOORS OR ON WET SURFACES.**

**⚠ WARNING:**  
**TO REDUCE THE RISK OF FIRE, ELECTRIC SHOCK OR INJURY:**

#### **GENERAL ELECTRICAL SAFETY:**

1. Unplug from electrical outlet when not in use and before servicing.
2. **DO NOT** use vacuum with a damaged cord or plug.
3. **DO NOT** pull or carry vacuum by the cord.
4. **DO NOT** unplug by pulling on cord; to unplug, grasp the plug, not the cord.
5. **DO NOT** handle plug or vacuum cleaner with wet hands.
6. **DO NOT** run the vacuum over the power cord.
7. **DO NOT** close a door on the cord.
8. **DO NOT** pull cord around sharp corners.
9. **DO NOT** leave appliance when plugged in.
10. Keep power cord away from heated surfaces.
11. Turn off all controls before plugging or unplugging vacuum cleaner.
12. Always turn off this appliance before connecting or disconnecting the motorized nozzle

#### **HOSE ATTACHMENTS:**

13. **DO NOT** use if air flow is restricted; if the air paths, the hose or the extension tube become blocked, turn the vacuum cleaner off. Remove all obstructions before you turn on the unit again.
14. Keep the end of the hose, wands and other openings away from face and body.



15. Keep rotating brush and suction openings away from hair, face, fingers, uncovered feet or loose clothing.

16. Only use manufacturer's recommended attachments.

#### **GENERAL USE:**

17. Use only as described in this manual.

18. **DO NOT** put any objects into openings.

19. Keep your work area well lit.

20. Keep the vacuum moving over the carpet surface at all times to avoid damaging the carpet fibers.

21. **DO NOT** place vacuum on unstable surfaces such as chairs or tables.

22. **DO NOT** allow young children to operate the vacuum or use as a toy.

23. **DO NOT** use vacuum cleaner if it has been dropped, damaged, left outdoors or submerged in water. Return to SharkNinja Operating LLC for examination, repair or adjustment.

#### **CYCLONIC CHAMBER/DUST CUP/FILTERS:**

24. Before turning on the vacuum:

- Make sure that dust cup, cyclonic chamber and all filters are in place after routine maintenance.
- Make sure that all components and filters are thoroughly dry after routine cleaning.
- Only use filters and accessories provided by SharkNinja Operating LLC [Failure to do so will void the warranty].

#### **GENERAL CLEANING:**

25. **DO NOT** run the vacuum over large-sized objects.

26. **DO NOT** pick up hard or sharp objects such as glass, nails, screws or coins that could damage the vacuum cleaner.

27. **DO NOT** pick up smoking or burning objects such as hot coals, cigarette butts, fireplace ash, or matches.

28. **DO NOT** use to pick up drywall dust.

29. **DO NOT** pick up flammable or combustible materials such as lighter fluid, gasoline, kerosene or use in areas where they may be present.

30. **DO NOT** pick up toxic solutions such as chlorine bleach, ammonia or drain cleaner.

31. **DO NOT** use in an enclosed space where vapors are present from paint, paint thinner, moth-proofing substances, flammable dust or other explosive or toxic materials.

32. **DO NOT** vacuum up any liquids.

33. **DO NOT** immerse vacuum cleaner in water or other liquids.

34. **DO NOT** use outdoors or on wet surfaces; use only on dry surfaces.

35. Use extra care when cleaning on stairs.

## **SAVE THESE INSTRUCTIONS**

# Getting Started

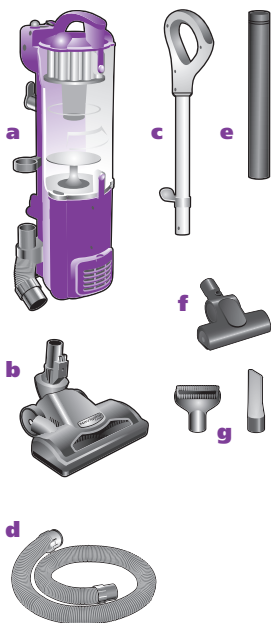

Along with your upright unit, you will find the following components:

- a** Vacuum Body
- b** Floor Power Nozzle
- c** Handle Assembly
- d** Super Stretch Hose
- e** Cleaning Wand
- f** Pet Hair Power Brush
- g** Cleaning Attachments

\* **Note:** Optional tools are available for sale for any NV26 model: 1-800-798-7398.

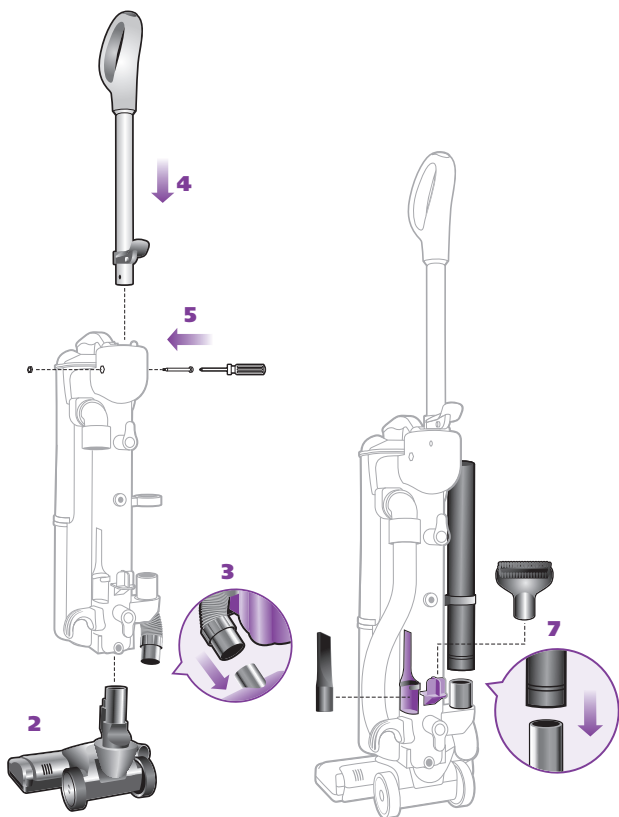

## Your Shark Navigator® Upright is easy to assemble:

- 1** Lay your vacuum body on a level surface.
- 2** Slide the electrical connection from the power nozzle into the main body to click into place.
- 3** Connect the hose from the main body to the power nozzle; push with a slight turning motion to create a snug fit.
- 4** Slide the handle assembly into the upright unit aligning the hose hook on the handle assembly with the power cord hooks on the back of the unit.
- 5** Secure the handle assembly in place with included nut/bolt (shipped attached to handle assembly).
- 6** Place the vacuum in the upright position.
- 7** Store the Crevice Tool, Dusting Brush and Cleaning Wand on the unit.

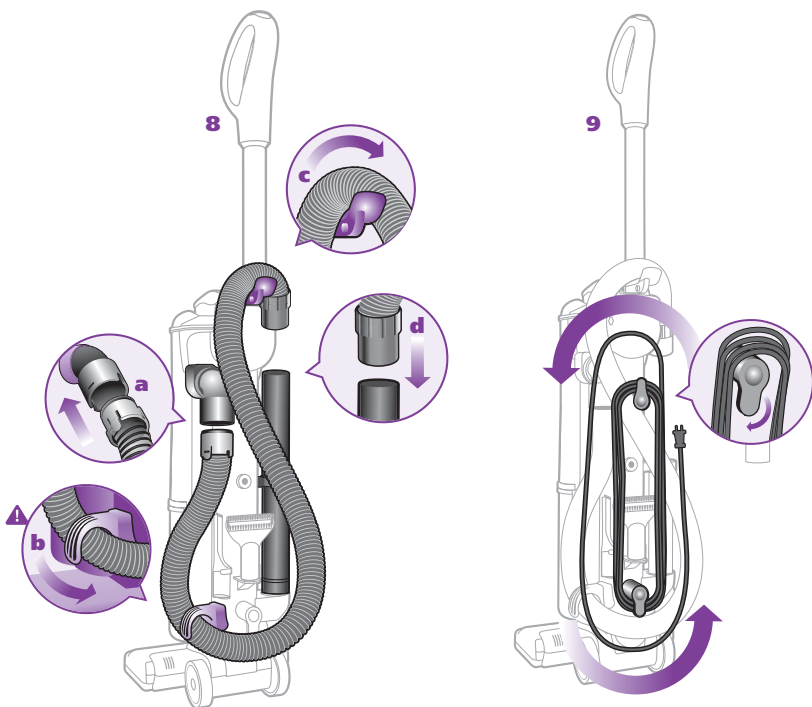

**8** Attach the Super Stretch Hose:

- a)** Snap hose into swivel connector
- b)** Route under anti-tip hook
- c)** Route over upper hose holder
- d)** Press securely onto cleaning wand

**! IMPORTANT:**

To prevent vacuum from tipping, secure hose under the anti-tip hose hook.



**9** When storing your vacuum, wind cord around the two cord holders and secure with cord clip:

- Quick Cord release at the top of the unit – place in the upright position.
- Second holder near the base – turn until it is pointing down.

To release the cord, turn the Quick Cord release to the left or right.

**! IMPORTANT:**

For suction to reach the Floor Power Nozzle, the Cleaning Wand and Super Stretch Hose must be attached securely on the vacuum body.

**10** To carry the vacuum:

With the unit in the standing position, lift by the Dust Cup Assembly Handle (carry handle).

- ! CAUTION:** When lifting or carrying, **DO NOT** press Dust Cup Assembly release button.

# Using the Vacuum

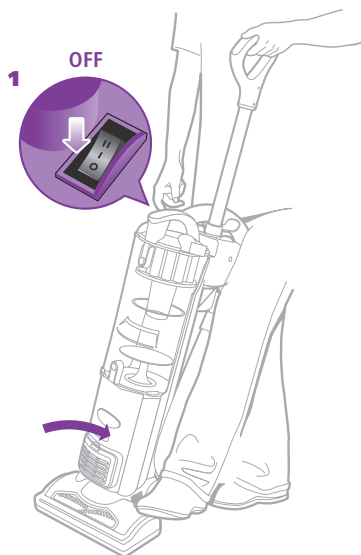

## Bare Floors / Tools



## Carpets

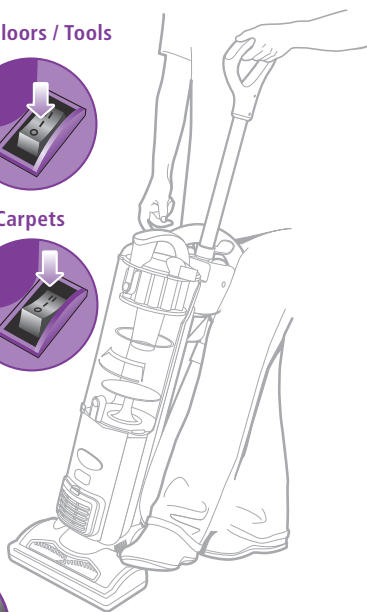

Indicator Light

Your Shark Navigator® Upright Vacuum is a versatile tool that can be used to clean bare floor surfaces or carpets – with the click of a switch.

Stand the vacuum into the upright position.

Plug in the vacuum.

- 1 Start with the Power Switch in the "O - Off" position.
- 2 Place your foot on the Floor Power Nozzle and pull handle towards you.
- 3 Set the Power Switch to desired cleaning setting.

## 4 When cleaning bare floors:

Select the "I - On" position for suction only cleaning to avoid scattering dirt while cleaning.

## When cleaning carpets:

Ensure you have pulled the handle towards you and select the "II Brush Roll On" position to agitate the carpet fibers for deeper cleaning performance.

## IMPORTANT:

To protect your carpets, the Brush Roll will only turn on when you have pulled the handle back towards you and released the Floor Power Nozzle.

## IMPORTANT:

Your Brush Roll Indicator Light will illuminate solid green when brush roll is on, or solid red if there is a blockage. This feature is designed to protect your Lifetime Belt that powers your Brush Roll. **See Checking for Blockages on page 11.**

## NOTE:

The height of your power nozzle has been optimized for easy pushing and superior cleaning on all floor types, so there is no need to make any height adjustments as you transition to different floor & carpet types.



# Cleaning with the Vacuum Accessories

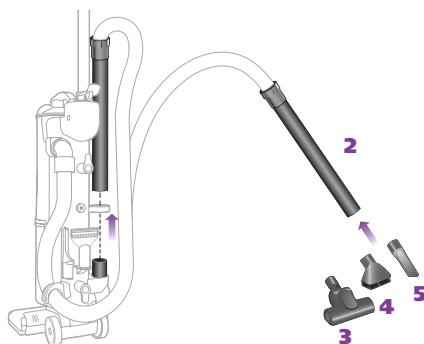
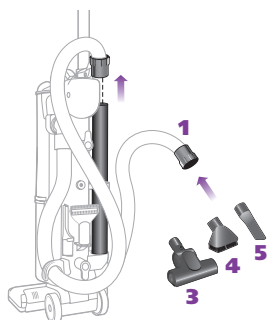
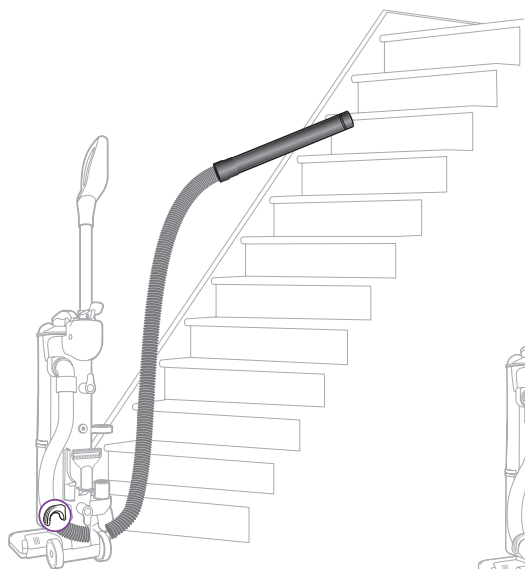

Before cleaning with your accessories:

Stand vacuum into upright position.

**Secure Super Stretch Hose in the anti-tip hose hook to prevent tipping.**



Select the "1 - On" position for suction only cleaning.

**!** DO NOT pull vacuum cleaner around by the hose.

**!** DO NOT overextend the hose.

## Vacuum Accessories

Your vacuum comes with a Super Stretch Hose and Cleaning Wand. Use one or the other to attach your cleaning accessories.

### 1 Using the Super Stretch Hose:

Stand the vacuum into upright position.

Remove the hose from the Cleaning Wand.

Push the selected tool into the hose connector.

### 2 Using the Cleaning Wand:

Stand the vacuum into upright position.

Remove the Cleaning Wand (with hose attached) from the unit.

Push the selected tool into the end of the Cleaning Wand.

### 3 Pet Hair Power Brush

### 4 Dusting Brush

### 5 Crevice Tool

To order additional parts and accessories, go to [www.sharkclean.com](http://www.sharkclean.com) or call 1-800-798-7398.

# Emptying the Dust Cup Assembly

For best results empty the Dust Cup Assembly after each use; empty several times during prolonged usage.

Or empty the Dust Cup Assembly when it reaches the **MAX** fill line; **NEVER OVER-FILL THE DUST CUP.**

Stand vacuum into upright position.

Turn vacuum off.

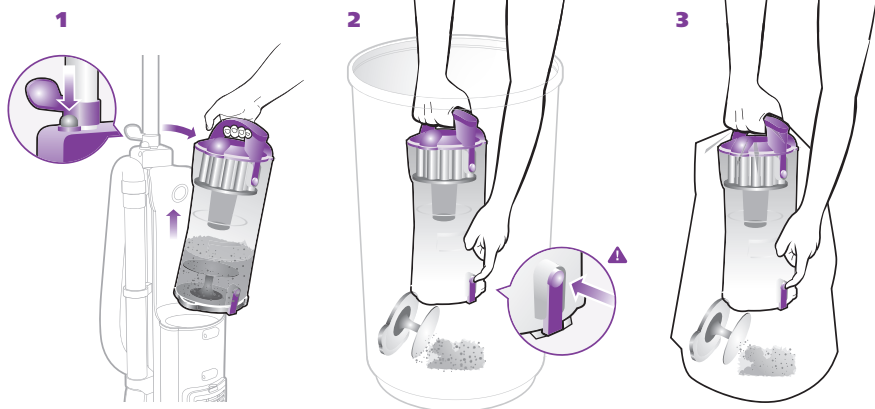

## To empty the Dust Cup Assembly:

- 1** Grip carry handle and press the Dust Cup release button to remove Dust Cup Assembly.
- 2 Option A:** For Quick Empty: Insert Dust Cup Assembly deep inside trash receptacle to contain dust and debris.  
Press the Dust Cup Door release button; tap container gently to dislodge and release dust and debris.

Snap door in place.

- ! Important:** If the Dust Cup Door does not swing open after pressing the release button, push the door open using the bottom door tabs.

- 3 Option B:** For Allergy Sufferers: Wrap a trash bag around the Dust Cup Assembly leaving space at the bottom for the door to swing open.

Locate the Dust Cup Door release button within the trash bag and press to release as you shake the dust cup to empty dust and debris.

Snap the bottom door in place.

- ! Note:** Option B can also be performed outside of the home to further minimize releasing dust back into the air. Carry just the Dust Cup Assembly and trash bag outside.

- ! Note:** Some dust and debris may remain in the top of your dust cup assembly on or near the metal screen. It is not necessary to completely remove this material before continuing to vacuum; Shark® advanced cyclonic action will sweep the metal screen clean once you begin to refill your dust cup.

# Proper Care of Your Upright Vacuum

Date Purchased: \_\_\_\_\_

For proper care, consult the table to the right for the maintenance schedule of your Cyclonic Chamber and Filters.

Lock vacuum into upright position.

Turn vacuum off.

Remove Dust Cup Assembly.

Component	Maintenance Schedule
<b>1</b> Cyclonic Chamber	Empty every 3 months, under normal use
<b>2</b> Foam Filters (2)	Wash every 3 months, under normal use
Felt Filter	Wash every 12 months, under normal use

## 1 Cleaning the Cyclonic Chamber:

### Option A: Quick Empty

Press the Cyclonic Chamber release button at the top of the Dust Cup Assembly and lift open the Dust Cup lid.

Remove the Cyclonic Chamber from the Dust Cup Assembly.

Insert the Cyclonic Chamber deep inside trash receptacle to contain dust. Press the Cyclonic Chamber Release Button to open and remove the bottom door.

Tap clean the open Cyclonic Chamber to release dust and then attach and close bottom door.

**⚠ Important:** Be careful not to damage the metal screen on the bottom of the Cyclonic Chamber when emptying. Tearing or changing the shape of this screen may disrupt the advanced cyclonic action and decrease the performance of your Dust Cup – requiring more frequent emptying of the Cyclonic Chamber.

Return Cyclonic Chamber to Dust Cup Assembly and close Dust Cup lid.

**⚠ DO NOT** operate your vacuum without the Cyclonic Chamber in place. Doing so would require more frequent washing of the foam filters, and could decrease the life of your vacuum.

### Option B: Allergy Sufferers

Carry the Dust Cup Assembly and a trash bag outside of your home.

Follow the instructions above for Option A, but instead of inserting Cyclonic Chamber into a trash receptacle wrap the trash bag around the Cyclonic Chamber.

## 2 Washing the Foam and Felt Filters:

Remove the Foam and the Felt Filters from the Filter Holder.

Rinse in lukewarm water until the water runs clear.

Squeeze filters and let air dry for 24 hours before replacing; do not use hair dryer or other heating methods to dry.

**⚠ DO NOT** operate the vacuum without ALL the filters in place.

**⚠ DO NOT** operate the vacuum with WET filters.

**Note:** Your 2 white foams and other filters will discolor over time; this is normal and will not affect the performance of the filters.

**Note:** It is NOT recommended to rinse the woven exhaust filter located on the front of the unit. This filter will continue to last the lifetime of your vacuum.

To order additional parts and accessories, go to [www.sharkclean.com](http://www.sharkclean.com) or call 1-800-798-7398.

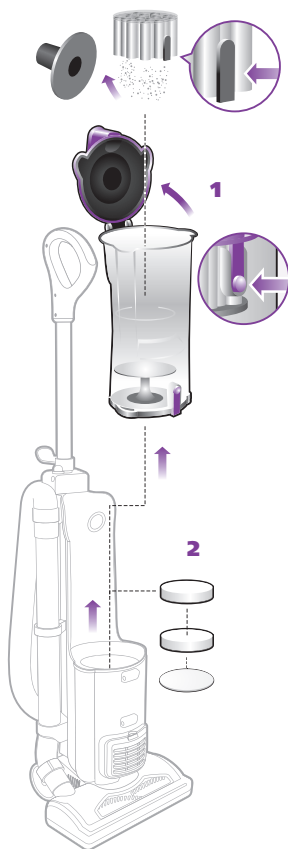

# Troubleshooting

## WARNING:

to reduce the risk of electric shock, the power cord must be disconnected before performing maintenance/troubleshooting checks.

Problem	Suggested Action
Vacuum will not run.	<p>Check to see if plugged in properly.</p> <p>Check circuit breaker/fuse.</p> <p>Check On/Off switch.</p> <p>If vacuum still does not run, see <b>Resetting the Motor Thermostat</b> on page 12.</p>
Vacuum is not picking up dirt.	<p>Check the Dust Cup.</p> <p>Check the Foam Filters.</p> <p>If the Dust Cup and Filter don't require cleaning, check for blockages, see <b>Checking for Blockages</b> on the next page.</p>
Vacuum pushes scatter rugs (lightweight, movable rugs) on <b>Power Switch position "II – Brush Roll on."</b>	<p>Move Power Switch setting to position "<b>I – suction only</b>" to disengage the Brush Roll.</p>
Brush roll does not turn on.	<p>Place your foot on the floor brush and pull the handle back to engage the Brush Roll.</p> <p>Select Power Switch position "<b>II – Brush Roll on.</b>"</p> <p>If red light is illuminated on the Floor Power Nozzle, see <b>Checking for Blockages</b> on next page.</p>
Vacuum turns off on its own.	<p>Motor Thermostat needs to be reset; see <b>Resetting the Motor Thermostat</b> on page 12.</p>
Airflow is restricted.	<p>Check for blockages; see <b>Checking for Blockages</b> on next page.</p> <p>Check attachments for suction strength; clear blockages, as required.</p> <p>Clean the Dust Cup, Cyclonic Chamber and the Foam Filters.</p>



# Checking for Blockages

Blockages may cause your vacuum to overheat and shut down. If so, clear the blockages, then follow the instructions for **Resetting the Motor Thermostat** on page 12.

**WARNING:** Never insert sharp objects into any opening to clear an obstruction.

**IMPORTANT:** Damages caused while clearing or attempting to clear blockages are not covered under your product's limited warranty.

Unplug the vacuum before checking for blockages.

Reassemble all parts securely before operating vacuum.

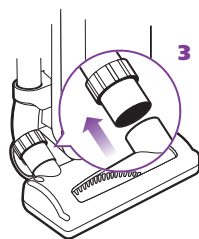
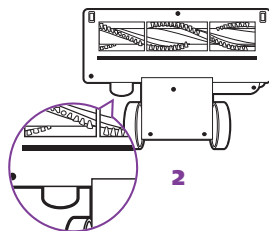
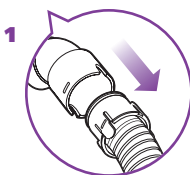
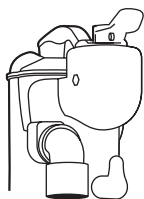
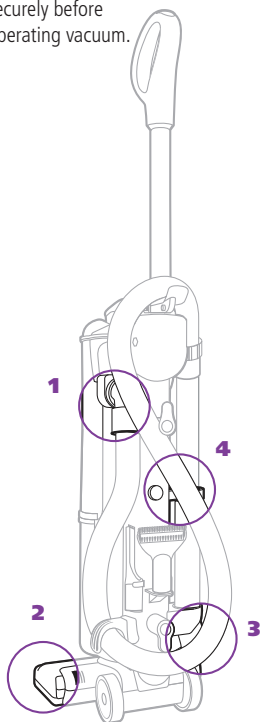

## 1 Dust Cup Air Duct:

Stand vacuum into upright position.

Remove Dust Cup Assembly and empty Dust Cup if necessary.

Disconnect the Super Stretch Hose.

Check Air Duct behind Dust Cup for clogs; clear before replacing Dust Cup Assembly.

## 2 Intake Opening behind the Brush Roll:

Lay the vacuum flat to expose Brush Roll.

Check opening behind the Brush Roll for clogs.

Clear the opening.

Clear the Brush Roll; use scissors to carefully cut away threads, hair or other debris that might be trapped in the bristles.

## 3 Floor Power Nozzle Hose Connector:

Lay vacuum flat.

Remove Nozzle Hose and check for clogs.

Push the Hose Connector back onto the Floor Power Nozzle.

## 4 Hose:

Stand vacuum upright.

Remove hose from both the unit and Cleaning Wand ends.

Inspect both ends and the length of the hose for clogs.

Return the hose to the unit

# Maintenance

## Resetting the Motor Thermostat

Your Shark® Upright Vacuum is equipped with a protective Motor Thermostat. If the motor should overheat, the thermostat shuts off the power.

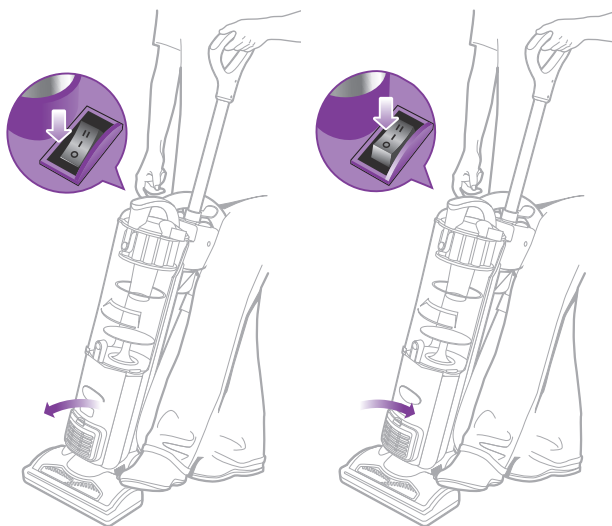

### To reset the Motor Thermostat:

Move the Power Button to the "O - Off" position.

Unplug the vacuum.

Check for clogged hose or filter; unclog hose and replace filter.

Refer to **Checking for Blockages** on page 11.

Wait 45 minutes for vacuum to cool; then plug in the vacuum.

Turn the Power Switch to the "I - On" position to start the vacuum.

Note: if vacuum still does not start, contact Customer Service at: 1-800-798-7398.

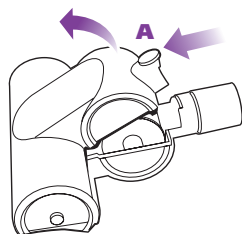

### 1 Cleaning the Pet Hair Power Brush -

Slide locking latch (A) forward.

Gently tilt brush housing upward to open.

**! IMPORTANT: DO NOT** force; it will not open all the way.

Remove debris from turbine wheel and air passage.

## Ordering Replacement Parts

To order additional parts and accessories, go to [www.sharkclean.com](http://www.sharkclean.com) or call 1-800-798-7398.

PART	PART NO.
Super Stretch Hose	1114-FC
Dusting Brush & Crevice Tool	1115-FC
Foam & Felt Filters	XF22
Turbo brush	1117-FC
Cleaning Wand	1116-FC

# Shark | NINJA

## FIVE (5) YEAR LIMITED WARRANTY

**SharkNinja Operating LLC** warrants this product to be free from defects in material and workmanship for a period of one (5) years from the date of the original purchase, when utilized for normal household use, subject to the following conditions, exclusions and exceptions.

If your appliance fails to operate properly while in use under normal household conditions within the warranty period, return the complete appliance and accessories, freight prepaid. For assistance with warranty service options or customer support, please call our customer care and product specialists at, call 1-800-798-7398 or visit our website [www.sharkclean.com](http://www.sharkclean.com).

If the appliance is found to be defective in material or workmanship, **SharkNinja Operating LLC** will repair or replace it free of charge. Proof of purchase is required and a fee of \$19.95 will apply to cover the cost of return freight. \*

The liability of **SharkNinja Operating LLC** is limited solely to the cost of the repair or replacement of the unit at our option. This warranty does not cover normal wear of parts and does not apply to any unit that has been tampered with or used for commercial purposes. This limited warranty does not cover damage caused by misuse, abuse, negligent handling or damage due to faulty packaging or mishandling in transit. This warranty does not cover damage or defects caused by or resulting from damages from shipping or repairs, service or alterations to the product or any of its parts, which have been performed by a repair person not authorized by **SharkNinja Operating LLC**.

This warranty is extended to the original purchaser of the unit and excludes all other legal and/or conventional warranties. The responsibility of **SharkNinja Operating LLC** warranty if any, is limited to the specific obligations expressly assumed by it under the terms of the limited warranty. In no event is **SharkNinja Operating LLC** liable for incidental or consequential damages of any nature whatsoever. Some states/provinces do not permit the exclusion or limitation of incidental or consequential damages, so the above may not apply to you.

This warranty gives you specific legal rights, and you may also have other rights which vary from state to state or province to province.

**\*Important: Carefully pack item to avoid damage in shipping. Be sure to include proof of purchase date and to attach tag to item before packing with your name, complete address and phone number with a note giving purchase information, model number and what you believe is the problem with the item. We recommend you insure the package (as damage in shipping is not covered by your warranty). Mark the outside of your package "ATTENTION CUSTOMER SERVICE".**

---

## Product Registration

Please visit [www.sharkclean.com](http://www.sharkclean.com) or call **1-800-798-7398** to register your new Shark® product within ten (10) days of purchase. You will be asked to provide the store name, date of purchase and model number along with your name and address.

The registration will enable us to contact you in the unlikely event of a product safety notification. By registering you acknowledge to have read and understood the instructions for use, and warnings set forth in the accompanying instructions.

SharkNinja Operating LLC

US: Newton, MA 02459

CAN: Ville St-Laurent, QC H4S 1A7

1-800-798-7398

[www.sharkclean.com](http://www.sharkclean.com)

Copyright © SharkNinja Operating LLC 2015

For Shark I Ninja U.S. Patent information visit <http://www.sharkninja.com/USPatents>

**SharkNinja and Shark Navigator** are trademarks of SharkNinja Operating LLC.

Illustrations may differ from actual product. We are constantly striving to improve our products, therefore the specifications contained herein are subject to change without notice.

NV26\_150806\_4