

Shark APEX™

DUOclean™

Powered Lift-Away®

AX950

Series

INSTRUCTIONS



sharkclean.com



1-800-798-7398

THANK YOU

for purchasing the Shark® APEX™ DuoClean™ Powered Lift-Away®



TIP: You can find the model and serial numbers on the QR code label which is located on the back of your unit behind the dust cup.

REGISTER YOUR PURCHASE



registeryourshark.com



1-800-798-7398



Scan QR code using mobile device

RECORD THIS INFORMATION

Model Number: _____

Serial Number: _____

Date of Purchase (Keep receipt): _____

Store of Purchase: _____

TECHNICAL SPECIFICATIONS

Voltage: 120V., 60Hz

Watts: 1350W

Amps: 11.3A

PLEASE READ CAREFULLY AND KEEP FOR FUTURE REFERENCE.

This instruction manual is designed to help you get a complete understanding of your new Shark APEX DuoClean Powered Lift-Away.

If you have any questions, please call the Customer Service line at 1-800-798-7398.

CONTENTS

Important Safety Instructions	3
Getting to Know Your Shark® APEX™ DuoClean™ Powered Lift-Away®	5
Assembling Your Vacuum	7
Using Your Vacuum in Upright Mode	9
What Does the Brushroll Indicator Light Mean?	9
Using Your Vacuum in Above-Floor Mode	11
Using And Storing Your Deep-Cleaning Motorized Pet Tool	12
Using Your Vacuum in Powered Lift-Away Mode	13
Powered Lift-Away Cleaning	13
Lift-Away Cleaning	14
Using Your Caddy	15
Compatible Accessories	17
Maintenance	19
Emptying the Dust Cup	19
Cleaning the Filters	20
Cleaning the Brushroll	21
Cleaning the Soft Roller	22
Checking the Nozzle for Blockages	22
Troubleshooting Guide	23
Warranty	26

IMPORTANT SAFETY INSTRUCTIONS

FOR HOUSEHOLD USE ONLY • PLEASE READ CAREFULLY BEFORE USE

⚠ WARNING

To reduce the risk of injury, fire, electric shock, and property damage resulting from improper use of the appliance, carefully observe the following instructions. This unit contains electrical connections and moving parts that potentially present risk to the user.

THE POWER NOZZLE, WAND, HOSE, AND HANDLE CONTAIN ELECTRICAL CONNECTIONS:

- There are **NO** serviceable parts.
 - **DO NOT** use to vacuum any liquids.
 - **DO NOT** immerse in water.
 - **DO NOT** use if handle/wand/hose is damaged, cut or punctured.
 - Avoid vacuuming up sharp objects.
 - Always turn off this appliance before connecting or disconnecting either hose, mechanical accessory, or motorized nozzle.
-

When using an electrical appliance, basic precautions should always be followed, including the following:

- 1** Inspect power cord and plug for any damage before use. **DO NOT** use vacuum cleaner with a damaged cord or plug. Turn off all controls before plugging in or unplugging the vacuum cleaner. Store your vacuum cleaner with the power cord secured around the two cord hooks.
- 2** **DO NOT** use outdoors or on wet surfaces. Use only on dry surfaces.
- 3** Unplug from electrical outlet when not in use and before servicing.
- 4** If vacuum cleaner is not working as it should, or has been dropped, damaged, left outdoors, or immersed in water, return it to SharkNinja Operating LLC for examination, repair, or adjustment.
- 5** **DO NOT** pull or carry vacuum cleaner by the cord or use the cord as a handle.

- 6** **DO NOT** unplug by pulling on cord. Grasp the plug, **NOT** the cord.
- 7** **DO NOT** handle plug or vacuum cleaner with wet hands.
- 8** **DO NOT** run the vacuum cleaner over the power cord, close a door on the cord, or pull the cord around sharp corners.
- 9** The use of an extension cord is **NOT** recommended.
- 10** **DO NOT** leave vacuum cleaner unattended when plugged in.
- 11** Keep cord away from heated surfaces.

GENERAL USE

- 12** Use only as described in this manual.
- 13** Keep your work area well lit.
- 14** Keep the vacuum cleaner moving over the carpet surface at all times to avoid damaging the carpet fibers.
- 15** **DO NOT** place vacuum cleaner on unstable surfaces such as chairs or tables.
- 16** **DO NOT** put any objects into openings. **DO NOT** use with any opening blocked; keep free of dust, lint, hair, and anything that may reduce airflow.
- 17** **DO NOT** allow young children to operate the appliance or use as a toy. Close supervision is necessary when any appliance is used near children.
- 18** **DO NOT** use unless brushroll, Soft Roller, dust cup, and all filters are in place.

SAVE THESE INSTRUCTIONS

DUST CUP/FILTERS/ACCESSORIES

Before turning on the vacuum:

- 19** Make sure that all filters are thoroughly dry after routine cleaning.
- 20** Make sure that dust cup and all filters are in place after routine maintenance.
- 21** Make sure accessories are free of blockages.
- 22** Use only Shark® brand filters and accessories. Using other brands will void warranty.

HOSE ATTACHMENTS

- 23 DO NOT** use if airflow is restricted. If the air paths or the motorized floor nozzle become blocked, turn the vacuum cleaner off and unplug from electrical outlet. Remove all obstructions before you turn on the unit again.
- 24** Keep the end of the hose and accessory openings away from face and body.
- 25** Keep cleaning tools and hose suction openings away from hair, face, fingers, uncovered feet, or loose clothing.
- 26** Only use manufacturer's recommended attachments.

GENERAL CLEANING

- 27 DO NOT** vacuum up large objects.
- 28 DO NOT** vacuum up hard or sharp objects such as glass, nails, screws, or coins that could damage the vacuum cleaner.

- 29 DO NOT** vacuum up drywall dust, fireplace ash, or embers. **DO NOT** use as an attachment to power tools for dust collection.
 - 30 DO NOT** vacuum up smoking or burning objects such as hot coals, cigarette butts, or matches.
 - 31 DO NOT** vacuum up flammable or combustible materials (e.g., lighter fluid, gasoline, or kerosene) or use vacuum in areas where they may be present.
 - 32 DO NOT** vacuum up toxic solutions (e.g., chlorine bleach, ammonia, or drain cleaner).
 - 33 DO NOT** use in an enclosed space where vapors are present from paint, paint thinner, moth-proofing substances, flammable dust, or other explosive or toxic materials.
 - 34 DO NOT** vacuum up any liquids.
 - 35 DO NOT** immerse vacuum cleaner in water or other liquids.
 - 36** Use extra care when cleaning on stairs.
-

POLARIZED PLUG

To reduce the risk of electric shock, this vacuum cleaner has a polarized plug (one blade is wider than the other). As a safety feature, this plug will fit into a polarized outlet only one way. If the plug does not fit fully into the outlet, reverse the plug. If it still does not fit, contact a qualified electrician. **DO NOT** force into outlet or try to modify to fit.

GETTING TO KNOW YOUR SHARK® APEX™ DUOCLEAN™ POWERED LIFT-AWAY®

WELCOME!

Congratulations on your purchase. Use this instruction manual to learn about your new vacuum's great features. From assembly to use to maintenance, you will find it all in here.

MAIN UNIT

- A** Power Switch
- B** Handle Release Button
- C** Surface Selector
- D** Hose Clip
- E** Hose
- F** Upper Cord Hook
- G** Powered Lift-Away Button
- H** Wand Release Button
- I** Lift-Away Pod
- J** Dust Cup Release Button
- K** Dust Cup Empty Latches
- L** Wand
- M** Lower Cord Hook
- N** Motorized Floor Nozzle
- O** Brushroll Indicator Light
- P** Headlights
- Q** Brushroll Garage
- R** Soft Roller

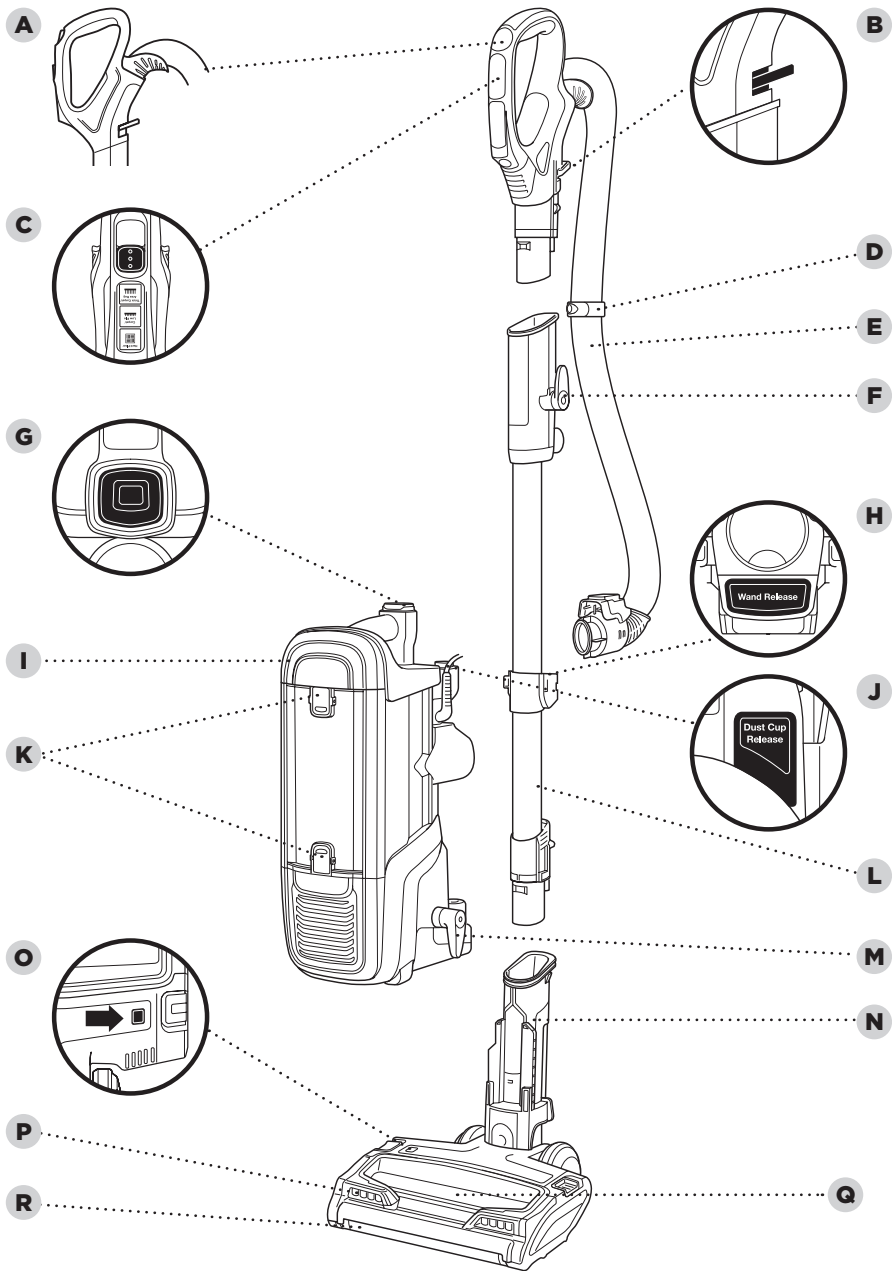

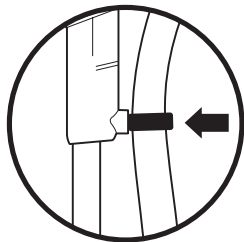

ASSEMBLING YOUR VACUUM

 **TIP:** Push hose clip into back of wand for convenience.

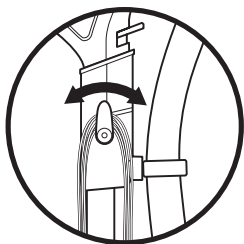

 **TIP:** For quick cord access, rotate upper hook down and remove cord.



 **TIP:** Use cord clip located on the side of wand to hold cord in place while vacuuming.

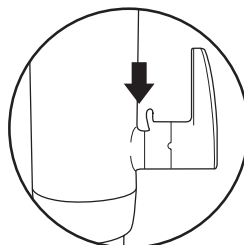

STEP 1

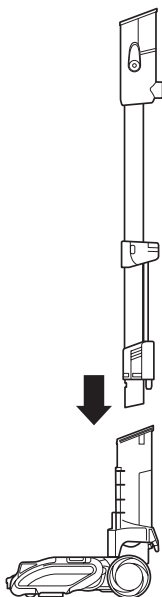

- 1** Place motorized floor nozzle on floor and insert wand, pressing it in until it clicks securely into place.

STEP 2

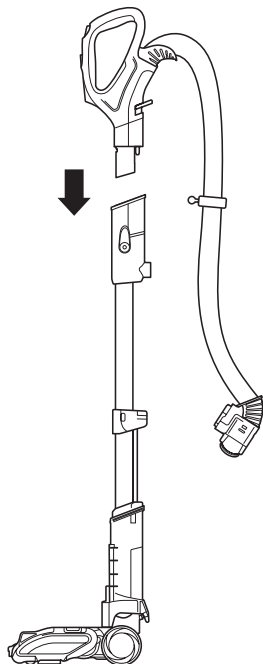

- 2** Insert handle into wand, pressing it in until it clicks securely into place.

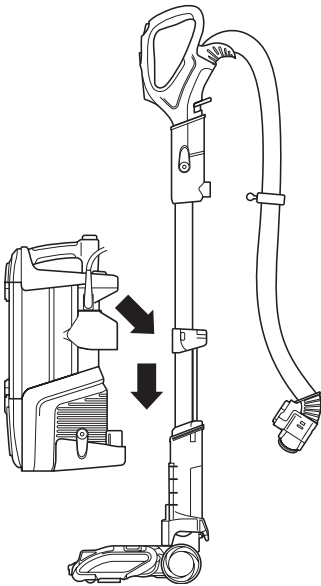
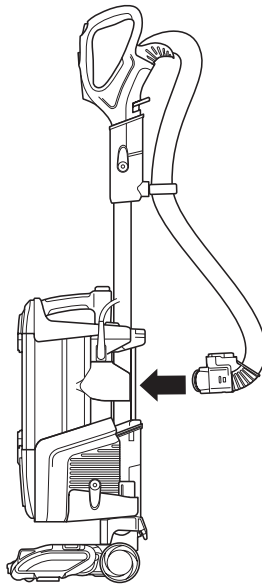
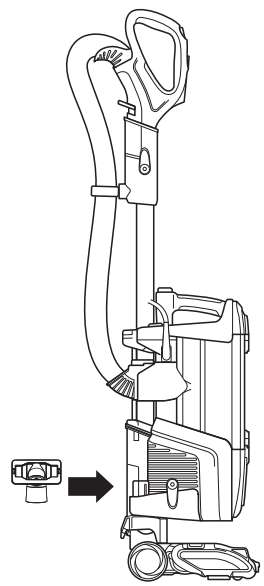
STEP 3**STEP 4****STEP 5**

- 3** Place pod onto wand and slide down to connect. **4** Connect hose into back of pod, pressing it in until it clicks securely into place. **5** Store included accessories on the accessory posts on the pod.

USING YOUR VACUUM IN UPRIGHT MODE

⚠ WARNING: DO NOT use to vacuum up drywall dust, fireplace ash, or embers. **DO NOT** use as an attachment to power tools for dust collection.

WHAT DOES THE BRUSHROLL INDICATOR LIGHT MEAN?

Solid Green

The brushrolls are spinning and working as they should.

Solid Red

There is a jam in the brushroll area. Turn off your vacuum and remove any blockages.

Flashing Red*

The motorized floor nozzle is overheating. Turn off your vacuum and wait for it to cool down. After vacuum has cooled, move Surface Selector switch to Thick Carpet mode, then press Power button to turn vacuum back on.

No Light

The brushrolls are not spinning because the vacuum is off.

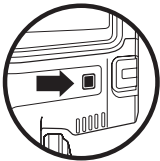

*See Troubleshooting section for further instructions.

STEP 1

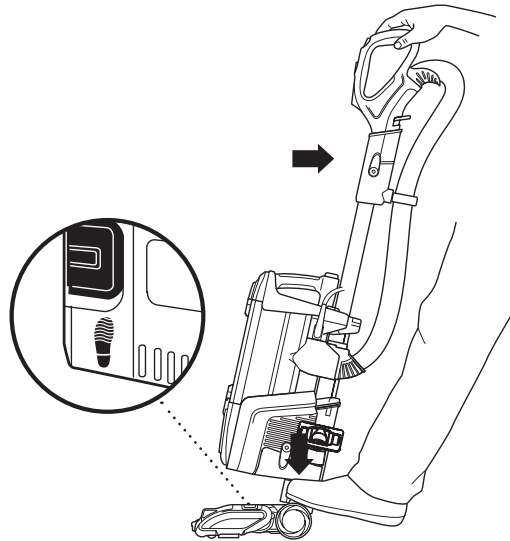

- 1 Plug power cord into outlet. Place foot on floor nozzle and tilt handle back.

STEP 2

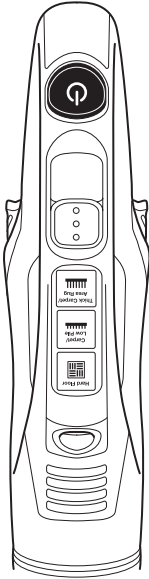

- 2** Press power button to turn on vacuum. Please note the brushrolls will not spin unless the wand is reclined.

STEP 3

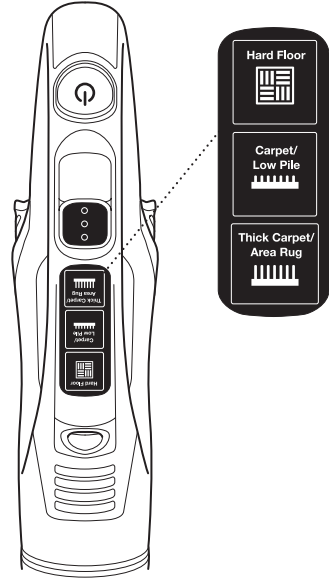

- 3** Choose the appropriate setting.

Thick Carpet & Area Rug Cleaning

Set floor selector to Thick Carpet/Area Rug.

Carpet & Low Pile Cleaning

Set floor selector to Carpet/Low Pile to increase the speed of your brushrolls and to help remove stuck-on dust and debris.

Hard Floor Cleaning

Set floor selector to Hard Floor.

NOTE: For deep cleaning per ASTM F 608 (embedded dirt in carpets) please set to Carpet/Low Pile.

USING YOUR VACUUM IN ABOVE-FLOOR MODE

STEP 1

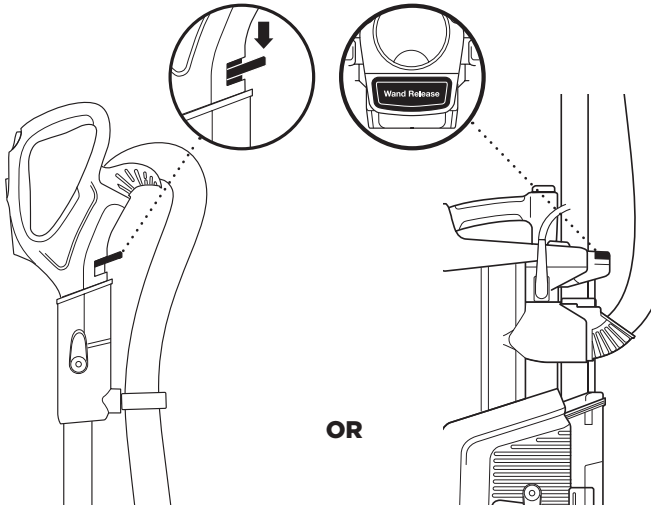

OR

STEP 2

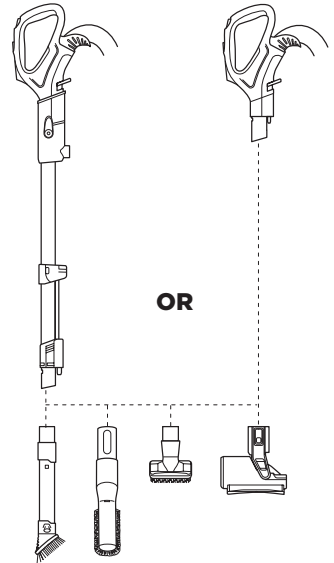

OR

1 To clean above-floor areas with the handle, detach it from the wand by pressing the Handle Release button.

OR To clean with a longer reach, detach the wand from the floor nozzle by pressing the Wand Release button.

2 Insert desired tool directly onto wand or handle.

USING AND STORING YOUR DEEP-CLEANING MOTORIZED PET TOOL

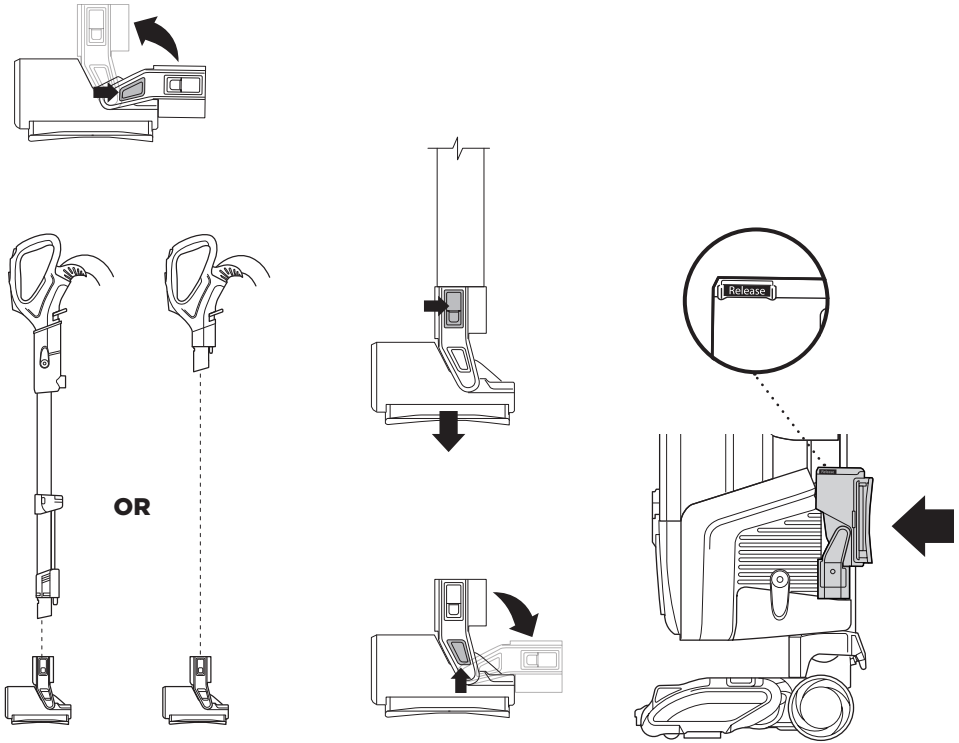

USING YOUR DEEP-CLEANING MOTORIZED PET TOOL

- 1 To use the tool, slide the Rotate button down, then rotate the cleaning head clockwise, until the head is in cleaning position, perpendicular to the base. Insert tool onto wand or handle.

STORING/REMOVING YOUR DEEP-CLEANING MOTORIZED PET TOOL

- 1 To store the tool on your vacuum, first press the Wand Release button to remove from the wand or handle.
- 2 Slide the Rotate button down, then rotate the cleaning head counterclockwise until the head is lined up with the base.

- 3 Place it on the left tool post (marked with tool icon) with orange release button facing outwards. Push forward until the tool clicks into place.
- 4 To remove tool from post, press orange Release button and pull the tool towards you, away from the vacuum.

USING YOUR VACUUM IN POWERED LIFT-AWAY® MODE

⚠ WARNING: Ensure solid footing when using in Lift-Away mode. Using vacuum when you don't have stable footing may result in personal injury.

WHAT IS POWERED LIFT-AWAY?

Our Powered Lift-Away feature allows you to remove the pod from the nozzle while maintaining the same power you have in upright mode. This is great for cleaning stairs, under furniture, and in other tight spaces.

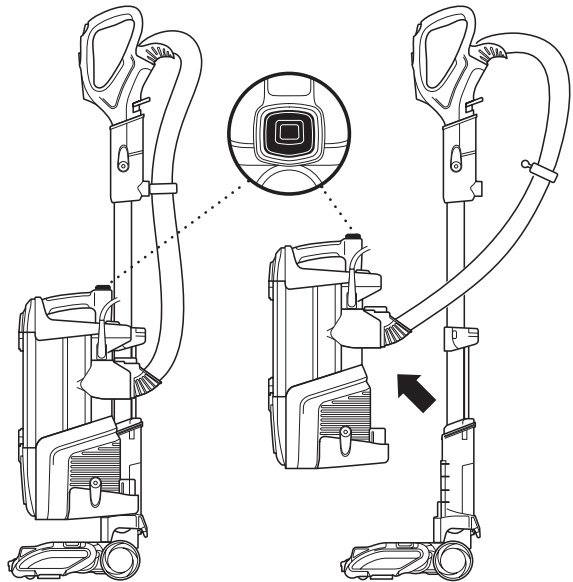

POWERED LIFT-AWAY CLEANING

- 1 Press Powered Lift-Away button to lift pod off floor nozzle. You are now ready to clean those hard-to-reach places.

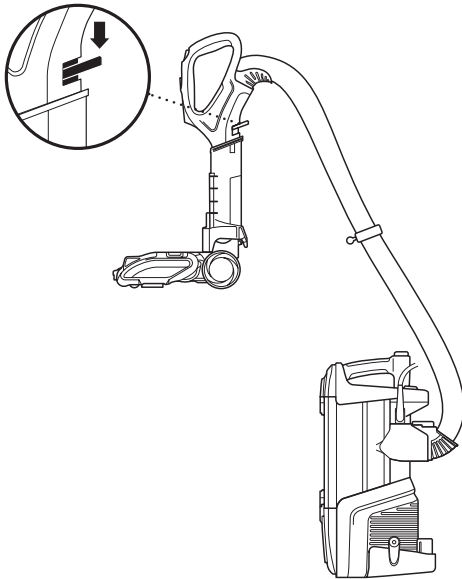

- 2** For a convenient way to clean stairs, detach wand and handle, then insert handle into motorized floor nozzle.

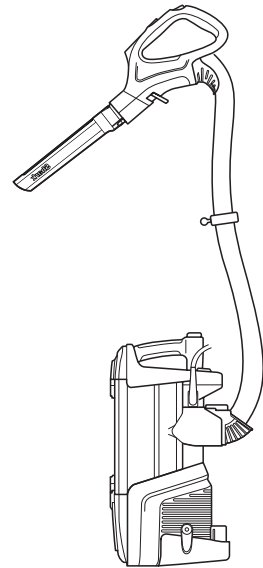

LIFT-AWAY® CLEANING

- 1** Attach desired accessory directly to the handle. For more cleaning reach, attach the wand to the handle, then attach accessory to the wand.

USING YOUR CADDY

If your vacuum comes with a caddy, use these instructions.

To purchase a caddy, visit sharkaccessories.com

TIP: Use the posts on the caddy to store additional cleaning accessories.

TIP: You can store the nozzle on the back of the caddy.

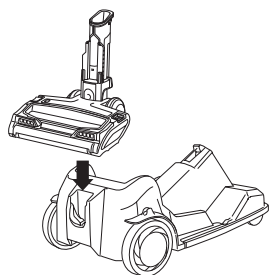

TIP: There is a cord clip on the caddy to help with cord management.

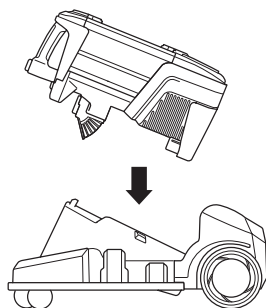
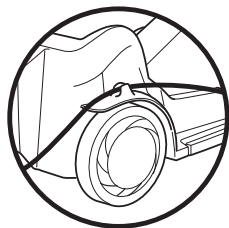

- 1 From Lift-Away® mode, place pod onto caddy.

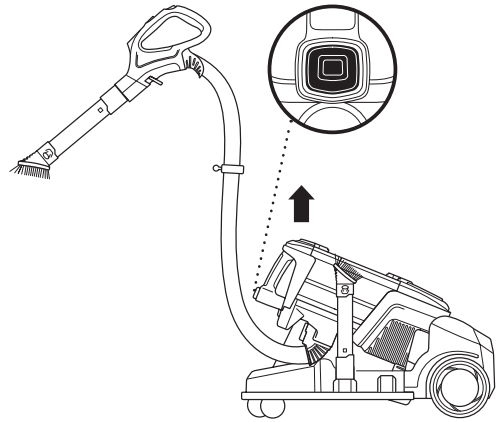
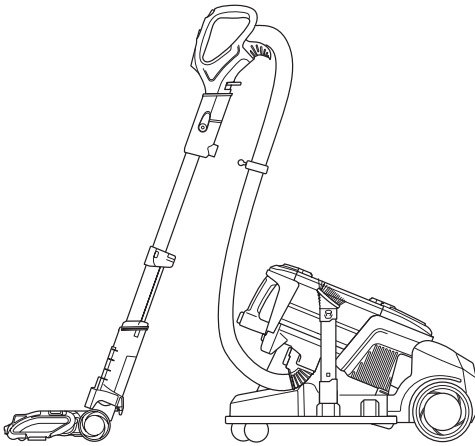

- 2** Cleaning in Powered Lift-Away® mode allows you to still use the motorized floor nozzle.
- 3** To clean above-floor areas, use the wand or the handle with an accessory attached. Press Wand Release button or Handle Release button, and attach preferred accessory.

REMOVING POD FROM CADDY

When you are done cleaning with your caddy, press the Powered Lift-Away button to remove pod.

COMPATIBLE ACCESSORIES

There are a variety of accessories that are compatible with this vacuum series.

The Quick Start Guide shows the select accessories that are included with your model.

To purchase additional accessories, visit sharkaccessories.com

A Mini Motorized Pet Brush

Designed to remove pet hair and ground-in dirt from carpeted stairs and upholstery.

B Duster Crevice

Two cleaning tools in one—the crevice tool gives you extended cleaning reach for small spaces, while the soft dusting brush cleans a multitude of surfaces.

C Caddy

Transforms your upright vacuum into a canister vacuum, giving you the freedom to roll the pod along while keeping cleaning tools close by.

D Pet Multi-Tool

Two tools for cleaning tough pet messes: first, a stiff bristle brush for cleaning stuck-on debris. Then remove the bristles to reveal an upholstery tool for cleaning stubborn pet hair.

E Anti-Allergen Dust Brush

Nylon fiber bristles specially designed for removing fine dust and allergen particles from the most delicate surfaces.

F Deep-Cleaning Motorized Pet Tool

Motorized compact brush powerful enough to remove deeply embedded allergens, dirt, and hair from multiple surfaces. Stores onboard for your convenience.

G MultiFlex™ Under Appliance Wand

Pivoting wand that extends to clean under appliances and on top of furniture.

A

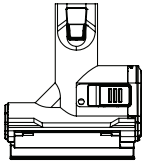

B

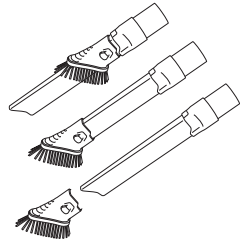

C

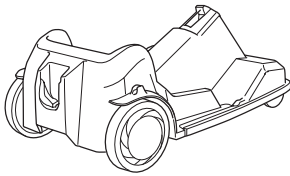

D

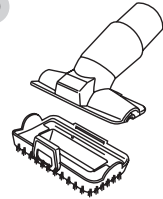

E

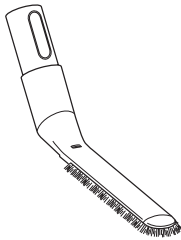

F

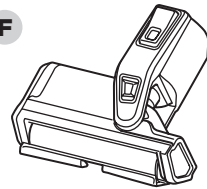

G

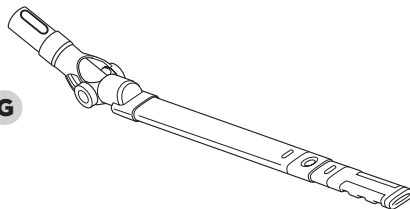

MAINTENANCE

To keep your vacuum's suction power optimal, follow these instructions. Make sure unit is off and cord is unplugged.

⚠ WARNING: To reduce the risk of shock and unintended operation, turn off power and unplug unit before servicing.

⚠ Hand wash only with water to prevent damage from cleaning chemicals. Allow ALL filters to air-dry completely before replacing them in the vacuum to prevent liquid from being drawn into electric parts.

★ IMPORTANT: Do not use soap when cleaning the filters. Do not scrub HEPA filter material.

RECOMMENDED FILTER CLEANING SCHEDULE:

Pre-Motor Filter Kit
(Foam & Felt)
XFF650
Clean every 3 months.

Post-Motor Filter
(HEPA)
XHF650
Clean once a year.

STEP 1

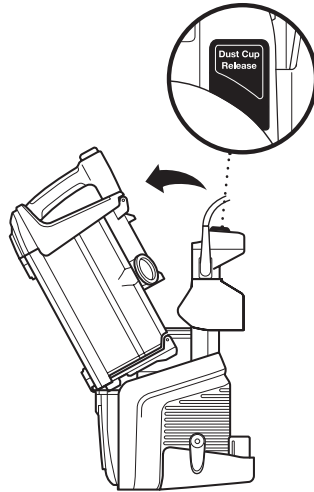

STEP 2

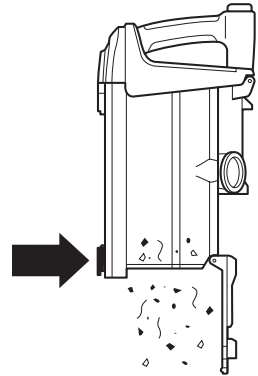

EMPTYING THE DUST CUP

- 1 Press down on Dust Cup Release button and lift dust cup off pod.
- 2 Hold dust cup over a trash bin and press the latch on the bottom of the dust cup to empty it.

STEP 3

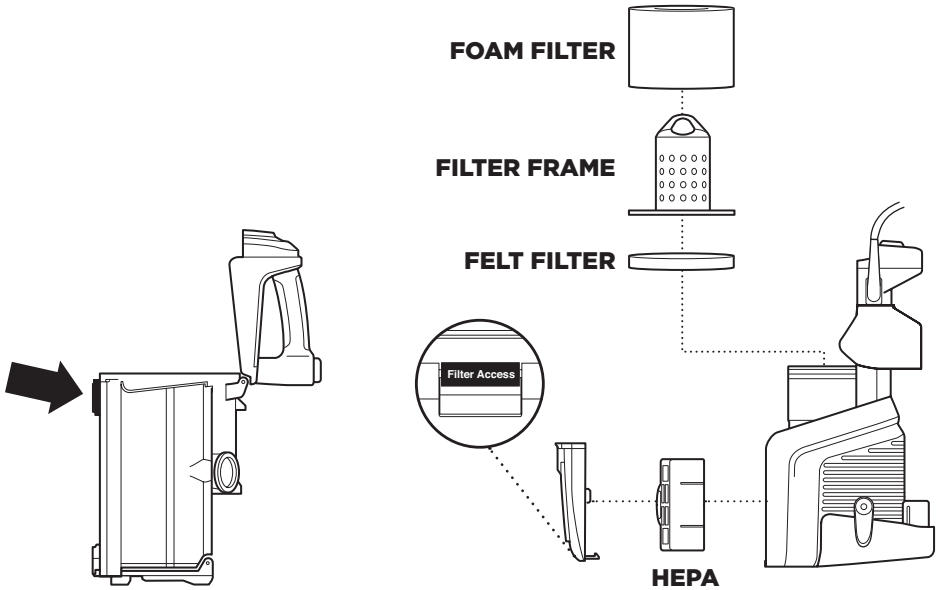

CLEANING THE FILTERS

3 Press top Dust Cup Empty latch to access dust screen and remove built-up debris as required.

1 Pre-Motor (foam and felt):

With the dust cup removed, take out the foam and felt filters, and rinse with water. Tap loose dirt off filters between washes as needed.

2 Post-Motor (HEPA):

To access the HEPA filter, reach under the grill, press the button, and pull the grill away from the vacuum. Remove and rinse the HEPA filter.

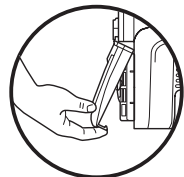

MAINTENANCE - continued

⚠ WARNING: To reduce the risk of shock and unintended operation, turn off power and unplug unit before servicing.

💡 TIP: You can also check for blockages in the hose and tubes. Just remove the floor nozzle, dust cup, and hose and shine a flashlight in the openings.

STEP 1

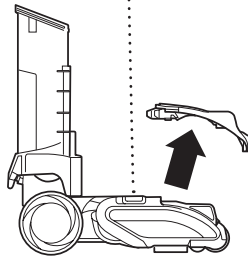
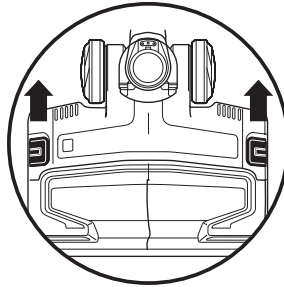

STEP 2

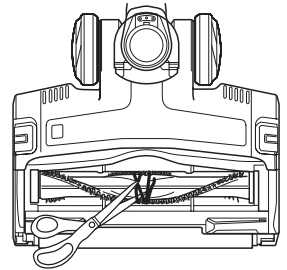

CLEANING THE BRUSHROLL

- 1** To open the brushroll garage, slide both release buttons on the floor nozzle away from you, towards the back of the nozzle, then lift off the brushroll garage lid.
- 2** To remove any string, hair or debris that may be wrapped around the brushroll, use scissors to cut along the groove in the brushroll.
- 3** To close the brushroll garage lid, insert the 3 tabs on top of lid into the 3 slots in the nozzle, then push down on both sides of lid until it clicks securely into place. If Brushroll Indicator Light isn't green and headlights are flashing, check again that both sides of lid are locked in place.

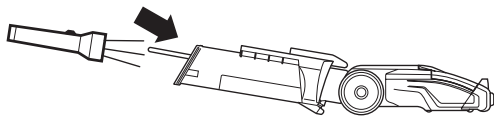
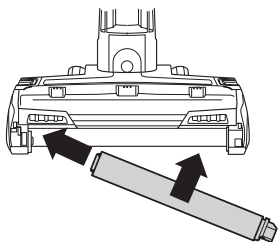
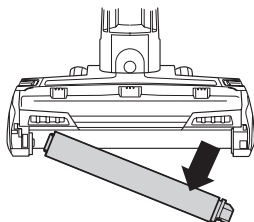

CLEANING THE SOFT ROLLER

- 1** To remove Soft Roller from nozzle, lift it out by the pull tab.
- 2** You can also tap loose debris off the Soft Roller, or wipe it clean with a dry towel. If you see any hair buildup or fibers caught in the teeth behind the Soft Roller, wipe clean with a dry towel.
- 3** Wash the Soft Roller as needed. Use only water, and let air-dry completely for at least 24 hours.

- 4** Reinsert Soft Roller under rubber bumper in front of nozzle until it clicks into place.

CHECKING THE NOZZLE FOR BLOCKAGES

- 1** Tilt neck of nozzle back to straighten the airway, then remove any blockages.

TROUBLESHOOTING GUIDE

⚠ WARNING: To reduce the risk of shock and unintended operation, turn power off and unplug unit before servicing.

This vacuum nozzle is specifically designed to pull in all types of debris and therefore can give the feeling of being self-propelled, especially on short carpets. If you'd like to feel less pull forward when using, you can change the handle mode setting from Carpet to either Hard Floor (for slower brush speed) or High Carpet (for less suction).

Vacuum is not picking up debris. No suction or light suction.
(Refer to Maintenance section for more information.)

- Check filters to see if they need cleaning. Follow instructions for rinsing and drying the filters before reinserting in the vacuum.
- Dust cup may be full; empty dust cup.
- Check hose, hose connections, nozzle, and accessories for blockages; clear blockages if required.
- Remove any string, carpet fibers, or hair that may be wrapped around the brushrolls.

Vacuum lifts area rugs.

- Turn off unit to disengage the brushrolls. Be sure to select Thick Carpet/Area Rug setting.
- Suction is powerful. Take care when vacuuming area rugs or rugs with delicately sewn edges.

Brushroll and/or Soft Roller does not spin or the Brushroll Indicator Light turns red.

- Turn off vacuum, and move it away from any obstruction. Turn on vacuum and tilt handle back to activate brushroll.
- If Brushroll Indicator Light on floor nozzle remains red, turn off vacuum and unplug. Disconnect nozzle and remove any blockages. Make sure brushroll garage lid is firmly locked into position on both sides. Plug in vacuum, turn on power, and tilt handle back to activate brushroll. If Brushroll Indicator Light isn't green and headlights are flashing, check again that both sides of lid are locked in place.
- If Brushroll Indicator Light is still red, please contact Customer Service at 1-800-798-7398.

The Brushroll Indicator Light on the floor nozzle doesn't light up (either green or red) when you tilt the handle back.

- Turn off the unit. Move the handle back up into the upright lock position and unplug the vacuum. Make sure the brushroll garage lid is firmly locked into position on both sides. Plug in the vacuum and turn on power, then tilt handle back to activate brushroll. If the Brushroll Indicator Light on the floor nozzle turns green, the issue has been fixed.
- If Brushroll Indicator Light is still red, please contact Customer Service at 1-800-798-7398.

Vacuum turns off on its own or Brushroll Indicator Light flashes red.

- This vacuum is equipped with a motor-protective thermostat. If your vacuum overheats, the thermostat will automatically turn the suction motor off. Perform the following steps to reset the thermostat:
 1. Turn vacuum off and unplug it.
 2. Empty dust cup and clean filters (see Maintenance section).
 3. Check for blockages in hose, accessories, and inlet openings.
 4. Allow unit to cool for a minimum of 45 minutes.
 5. Plug in vacuum and turn it on.
- If hose is not fully connected to the pod, it can cause a poor electrical connection and the hose can come loose, turning the vacuum off.
 1. Turn vacuum off and unplug it.
 2. Empty dust cup and clean filters.
 3. Check for blockages in hose, accessories, and inlet openings.
 4. Remove cord from cord hook so hose latch can be seen and engaged.
 5. Ensure that hose, wand, and handle are all clicked securely into place at all connection points:
 - a. Where hose meets back of pod (may require additional force; pull on hose to ensure latch is fully engaged)
 - b. Where wand plugs into floor nozzle
 - c. Where handle plugs into wand
 6. Plug in vacuum and turn it on.

Note: If vacuum still does not run properly, contact Customer Service at 1-800-798-7398.

Shark | NINJA SEVEN (7) YEAR LIMITED WARRANTY

The 7-Year Limited Warranty applies to purchases made from authorized retailers of **SharkNinja Operating LLC**. Warranty coverage applies to the original owner and to the original product only and is not transferable.

SharkNinja warrants that the unit shall be free from defects in material and workmanship for a period of 7 years from the date of purchase when it is used under normal household conditions and maintained according to the requirements outlined in this instruction manual, subject to the following conditions and exclusions.

What is covered in my warranty?

1. The original unit and/or non-wearable components deemed defective, in SharkNinja's sole discretion, will be repaired or replaced for up to 7 years from the original purchase date.
2. In the rare event that a replacement unit is issued, the warranty coverage ends six months following the receipt date of the replacement unit or the remainder of the existing warranty, whichever is greater. If the unit is replaced, SharkNinja reserves the right to replace the unit with one of equal or greater value.

What is not covered in my warranty?

Our Customer Service/Product Specialists are available to provide all the warranty service options available to you, including the possibility of upgrading to our VIP Warranty Service Options for select product categories.

1. Normal wear and tear of wearable parts such as foam filters, HEPA filters, pads etc., which require regular maintenance and/or replacement to ensure the proper functioning of your unit are not covered by this warranty.
2. Any unit that has been tampered with or used for commercial purposes.
3. SharkNinja will cover the cost for the customer to send in the unit to us for repair or replacement. A fee of \$19.95 for return shipping costs will be charged at the time of return shipment of the repaired or replacement unit.
4. Damage caused by misuse, abuse, or negligent handling, or damage due to mishandling in transit.
5. Consequential and incidental damages.
6. Defects caused by or resulting from damages from shipping or from repairs, service, or alteration to the product or any of its parts which have been performed by a repair person not authorized by SharkNinja.
7. Products purchased, used or operated outside of North America.

Problems with your unit/How to get service

If your appliance fails to operate properly while in use under normal household conditions within the warranty period, visit sharkclean.com for product care/maintenance self-help. Our Customer Service and product specialists are also available at 1-800-798-7398 to assist with product support and warranty service options.

How to initiate a warranty claim

You can call 1-800-798-7398 to have a Customer Service specialist assist you. Please note you must call 1-800-798-7398 to initiate a warranty claim. Return and Packing Instruction information will be provided at that time.

For Customer Service hours, visit sharkclean.com.

Replacement parts are available for purchase at sharkclean.com. For more information on which parts are classified as wearable and non-wearable, please visit sharkclean.com/warranty.

This warranty gives you specific legal rights, and you also may have other rights that vary from state to state.

Some states do not permit the exclusion or limitation of incidental or consequential damages, so the above may not apply to you.



SharkNinja Operating LLC
US: Needham, MA 02494
CAN: Ville St-Laurent, QC H4S 1A7
1-800-798-7398
sharkclean.com

Illustrations may differ from actual product. We are constantly striving to improve our products; therefore the specifications contained herein are subject to change without notice.

SHARK, LIFT-AWAY, and POWERED LIFT-AWAY are registered trademarks of SharkNinja Operating LLC.

APEX, DUOCLEAN, and MULTIFLEX are trademarks of SharkNinja Operating LLC.

For SharkNinja U.S. Patent information visit sharkninja.com/USPatents.

