

Shark[®] ***Rocket***[®]

AH400

Model

INSTRUCTIONS

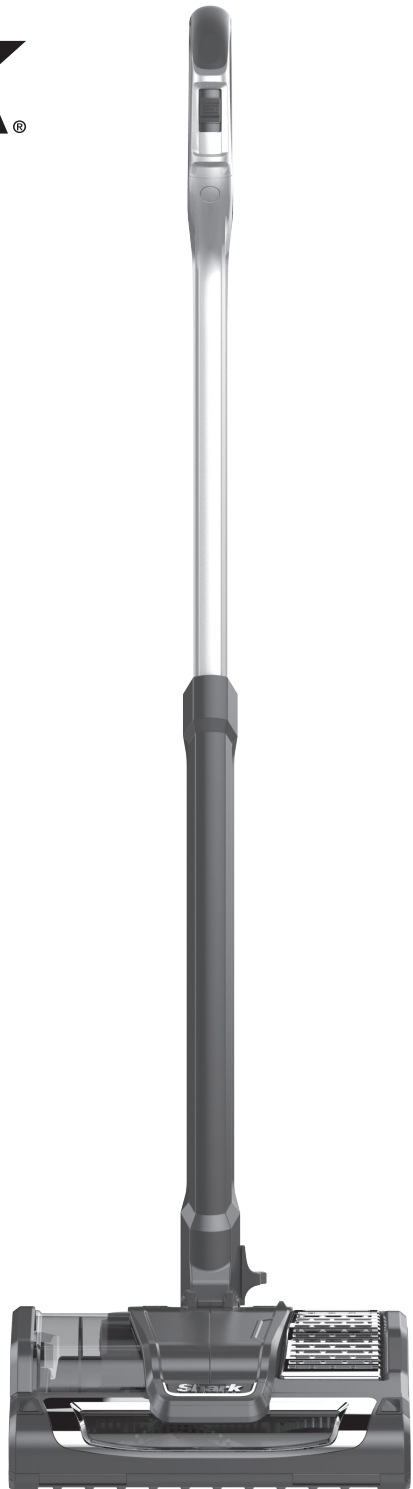

 sharkclean.com

 1-800-798-7398

THANK YOU

for purchasing the Shark® Rocket® Powerhead

REGISTER YOUR PURCHASE

 sharkclean.com

 1-800-798-7398

 **TIP:** You can find the model number on the rating label located on the back of your unit.

 **TIP:** You can locate the date code on one of the prongs of the power cord plug.

RECORD THIS INFORMATION

Model Number: _____

Date Code: _____

Date of Purchase (Keep receipt): _____

Store of Purchase: _____

TECHNICAL SPECIFICATIONS

Voltage: 120V., 60Hz

Watts: 600W

Amps: 5A

PLEASE READ CAREFULLY AND KEEP FOR FUTURE REFERENCE.

These instructions are designed to help you get a complete understanding of your new Shark Rocket Powerhead.

If you have any questions, please call the customer service line at 1-800-798-7398.

CONTENTS

Important Safety Instructions	3
Getting To Know Your Shark® Rocket® Powerhead	5
Assembling Your Vacuum	7
What Does the Brushroll Indicator Light Mean?	7
Vacuuming	8
Storage	8
Speed Settings	9
Choosing The Appropriate Setting	10
Suction Control	10
All-Surface Brushroll.....	10
Maintenance	11
Emptying the Dust Cup.....	11
Cleaning the Filters.....	13
Accessing & Cleaning the Brushroll	15
Troubleshooting Guide	17
Warranty	18

IMPORTANT SAFETY INSTRUCTIONS

FOR HOUSEHOLD USE ONLY

⚠ WARNING

To reduce the risk of injury, fire, electric shock, and property damage resulting from improper use of the appliance, carefully observe the following instructions. This unit contains electrical connections and moving parts that potentially present risk to the user.

THE FLOOR NOZZLE, WAND, AND HANDLE CONTAIN ELECTRICAL CONNECTIONS:

- These are not serviceable parts.
 - Do not use to vacuum any liquids.
 - Do not immerse in water.
 - If handle/wand is damaged, discontinue use.
-

- 1** Inspect power cord and plug for any damage before use. **DO NOT** use vacuum cleaner with a damaged cord or plug. Turn off all controls before plugging in or unplugging the vacuum cleaner. Store your vacuum cleaner with the power cord secured around the two cord hooks.
- 2** **DO NOT** use outdoors or on wet surfaces. Use only on dry surfaces.
- 3** Unplug from electrical outlet when not in use and before servicing.
- 4** If vacuum cleaner is not working as it should, or has been dropped, damaged, left outdoors, or dropped into water, return it to SharkNinja Operating LLC for examination, repair, or adjustment.
- 5** **DO NOT** pull or carry vacuum cleaner by the cord or use the cord as a handle.
- 6** **DO NOT** unplug by pulling on cord. Grasp the plug, not the cord.

- 7** **DO NOT** handle plug or vacuum cleaner with wet hands.
- 8** **DO NOT** run the vacuum cleaner over the power cord, close a door on the cord or pull the cord around sharp corners.
- 9** The use of an extension cord is **NOT** recommended.
- 10** **DO NOT** leave vacuum cleaner when plugged in.
- 11** Keep cord away from heated surfaces.
- 12** Always turn off the vacuum cleaner before connecting or disconnecting motorized nozzle.

GENERAL USE

- 13** Use only as described in this manual.
- 14** Keep your work area well lit.
- 15** Keep the vacuum cleaner moving over the carpet surface at all times to avoid damaging the carpet fibers.
- 16** **DO NOT** place vacuum cleaner on unstable surfaces such as chairs or tables.
- 17** **DO NOT** put any objects into openings. **DO NOT** use with any opening blocked; keep free of dust, lint, hair, and anything that may reduce airflow.
- 18** **DO NOT** allow the appliance to be used by children. Close attention is necessary when used near children. This is not a toy.
- 19** **DO NOT** use without dust cup and/or filters in place.

SAVE THESE INSTRUCTIONS

PLEASE READ CAREFULLY BEFORE USE

20 DO NOT use if airflow is restricted. If the air paths or the floor nozzle become blocked, turn the vacuum cleaner off and unplug from electrical outlet. Remove all obstructions before you turn on the unit again.

21 Keep nozzle away from hair, face, fingers, uncovered feet, or loose clothing.

22 Only use manufacturer's recommended attachments.

DUST CUP/FILTERS/ACCESSORIES

Before turning on the vacuum:

23 Make sure that all filters are thoroughly dry after routine cleaning.

24 Make sure that dust cup and all filters are in place after routine maintenance.

25 Make sure brushrolls are free of blockages by removing hair and carpet fibers.

26 Only use Shark-brand filters and accessories (failure to do so will void the warranty).

GENERAL CLEANING

27 DO NOT vacuum up large objects.

28 DO NOT vacuum up hard or sharp objects such as glass, nails, screws, or coins that could damage the vacuum cleaner.

29 DO NOT vacuum up drywall dust, fireplace ash, or embers. DO NOT use as an attachment to power tools for dust collection.

30 DO NOT vacuum up smoking or burning objects such as hot coals, cigarette butts, or matches.

31 DO NOT vacuum up flammable or combustible materials (e.g., lighter fluid, gasoline, or kerosene) or use vacuum in areas where they may be present.

32 DO NOT vacuum up toxic solutions (e.g., chlorine bleach, ammonia, or drain cleaner).

33 DO NOT use in an enclosed space where vapors are present from paint, paint thinner, moth-proofing substances, flammable dust, or other explosive or toxic materials.

34 DO NOT vacuum up any liquids.

35 DO NOT immerse vacuum cleaner in water or other liquids.

36 Use extra care when cleaning on stairs.

37 Remove brushroll from unit before rinsing.

.....

POLARIZED PLUG

To reduce the risk of electric shock, this vacuum cleaner has a polarized plug (one blade is wider than the other). As a safety feature, this plug will fit into a polarized outlet only one way. If the plug does not fit fully into the outlet, reverse the plug. If it still does not fit, contact a qualified electrician. DO NOT force into outlet or try to modify to fit.

GETTING TO KNOW YOUR SHARK® ROCKET® POWERHEAD

WELCOME!

Congratulations on your purchase. Use this instruction manual to learn about your new vacuum's great features. From assembly to use to maintenance, you will find it all in here.

MAIN UNIT

- A** Power/LO/HI Switch
- B** Upper Cord Hook
- C** Wand
- D** Pre-Motor Filters
- E** Lower Cord Hook
- F** Dust Cup
- G** Dust Cup Release Foot Pedal
- H** Brushroll Indicator Light
- I** Suction Control
- J** Brushroll Cover Release
- K** Exhaust Grill/Post-Motor Filter

ACCESSORIES

- L** All-Surface Brushroll

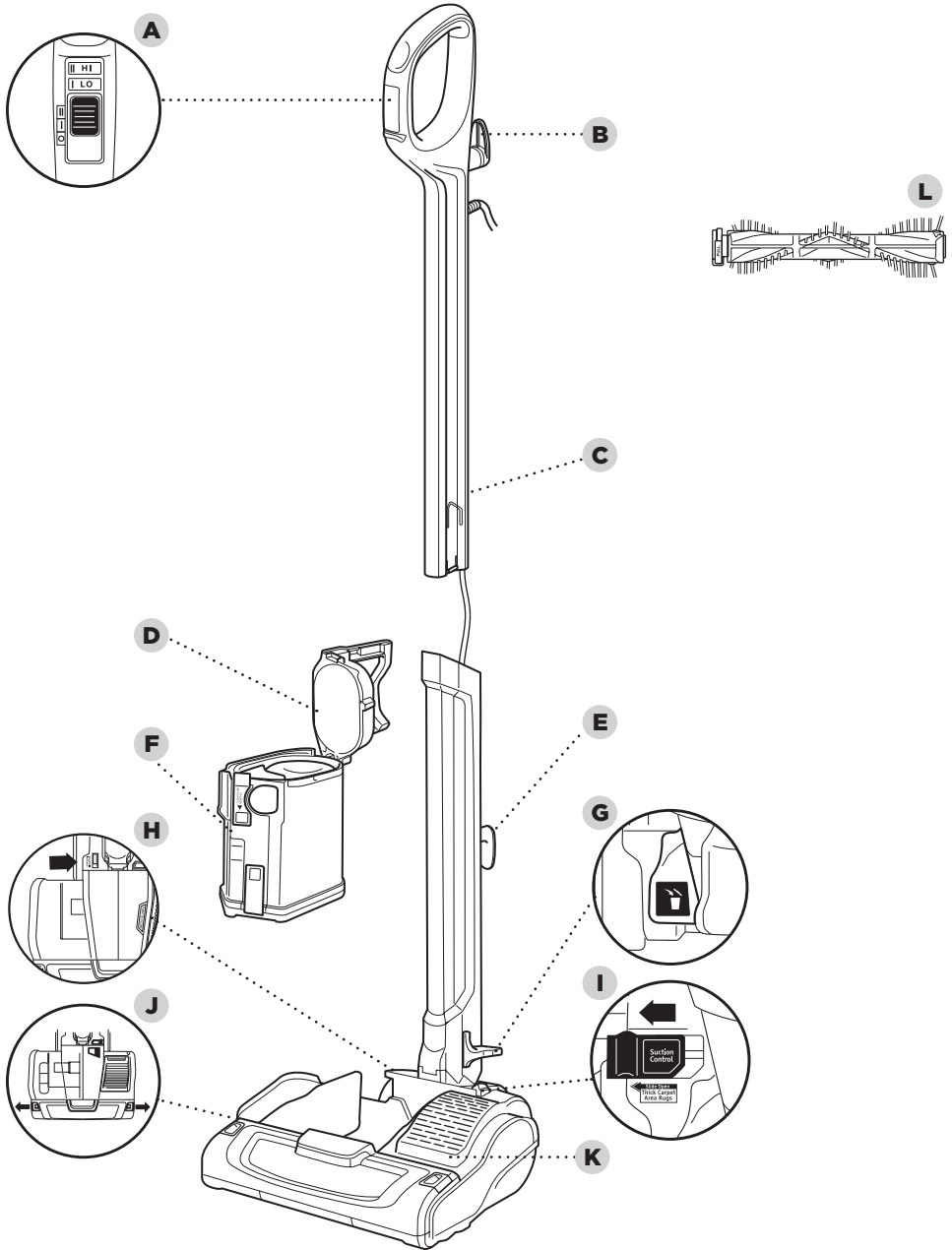

ASSEMBLING YOUR VACUUM

★ **IMPORTANT:** Always inspect wires for damage before assembly.

💡 **TIP:** For quick cord access, rotate upper hook down and remove cord. Rotate back up for cord storage.

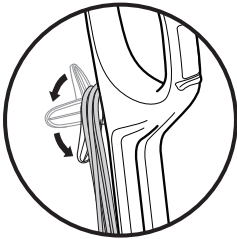

WHAT DOES THE BRUSHROLL INDICATOR LIGHT MEAN?

Solid Green

The brushroll is on and working as it should.

Solid Red

There is a jam in the brushroll area. Turn your vacuum off and remove the blockage.

Flashing Red*

The floor nozzle is overheating. Turn your vacuum off and wait for it to cool down.

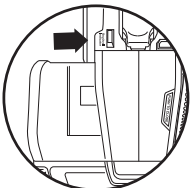

*See Troubleshooting section for further instructions.

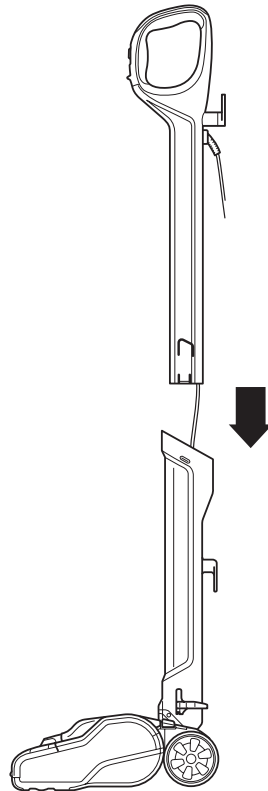

- 1 Insert upper part of the wand into lower portion until you hear a click. Make sure not to pinch the wires.

VACUUMING

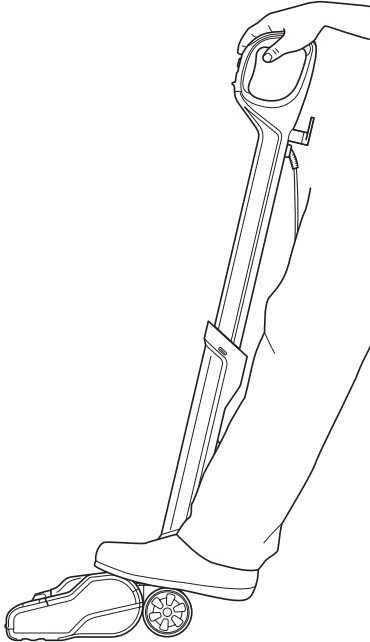

- 2** Plug power cord into electrical outlet. Step on floor nozzle and pull wand back. Select appropriate vacuum setting and start cleaning. Please note, the brushroll will not spin unless the wand is reclined.

STORAGE

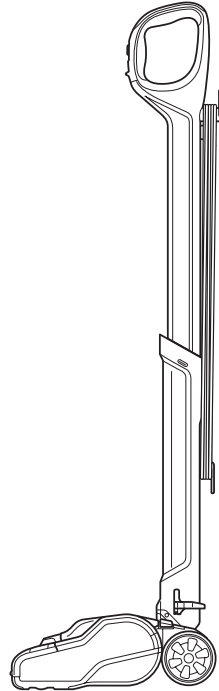

- 2** Wrap the power cord around the cord hooks.

SPEED SETTINGS

 **NOTE:** Before vacuuming your delicate area rugs or carpets, refer to the manufacturer's recommended cleaning instructions.

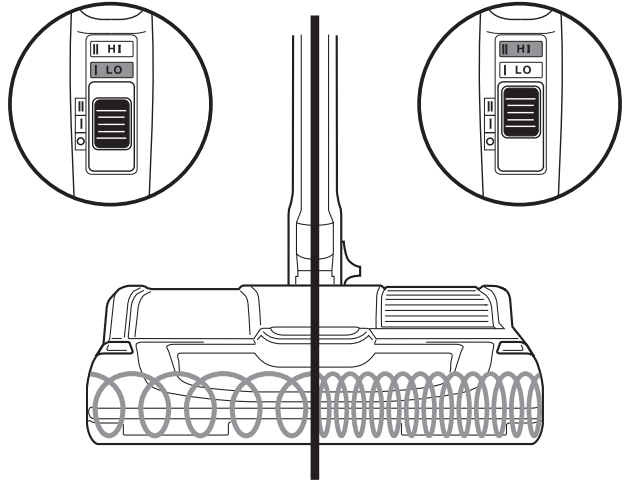

The Powerhead has a 2-speed Power slider switch on the handle.

LO - The brushroll spins slowly.

HI - The brushroll spins quickly.

CHOOSING THE APPROPRIATE SETTING

Less Suction

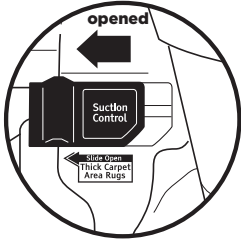

More Suction

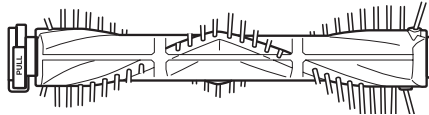
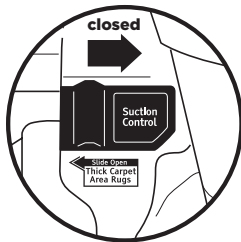

SUCTION CONTROL

This unit has a Suction Control slider to help with push/pull on high-pile carpets and to release suction when vacuuming area rugs. Open to minimize suction. Close for maximum suction.

ALL-SURFACE BRUSHROLL

The All-Surface Brushroll can be used on all floor types.

LO - For gentle cleaning on hard floors and area rugs.

HI - For deep-cleaning carpets by removing embedded dirt.

- 1** Plug the unit into an electrical outlet.
- 2** Slide the Power switch to the LO position to gently clean hard floors and area rugs. The brushroll will spin slowly.
- 3** Slide the Power switch to the HI position to deep-clean carpets by removing embedded dirt. The brushroll will spin quickly.

NOTE: For deep carpet cleaning per ASTM F608 (embedded dirt in carpets) please use the All-Surface brushroll on HI setting with the Suction Control closed.

MAINTENANCE

⚠ WARNING: To reduce the risk of shock and unintended operation, turn power off and unplug unit before servicing.

🔧 NOTE: Clean the dust screen inside the dust cup as required.

🔧 NOTE: The unit will only run when the dust cup is locked into place.

🔧 NOTE: Empty dust cup when debris reaches the MAX fill line.

STEP 1

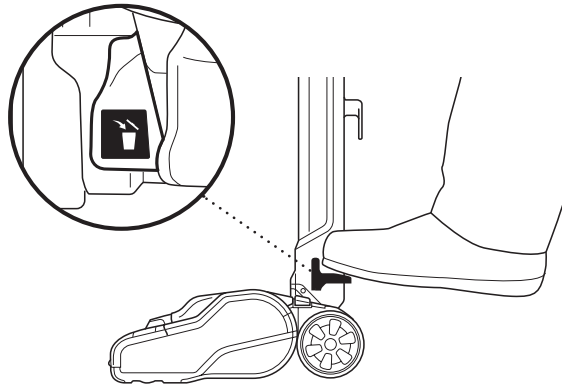

EMPTYING THE DUST CUP

- 1 Detach the removable dust cup from the floor nozzle by pressing the dust cup release pedal located on the left side near the nozzle.

STEP 2

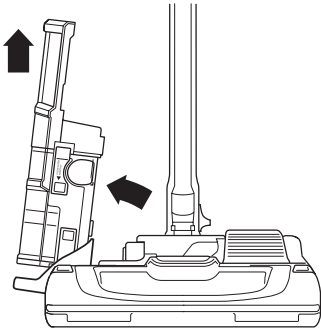

- 2** Once the dust cup pops up, hold it by the handle and lift up to remove it from the floor nozzle.

STEP 3

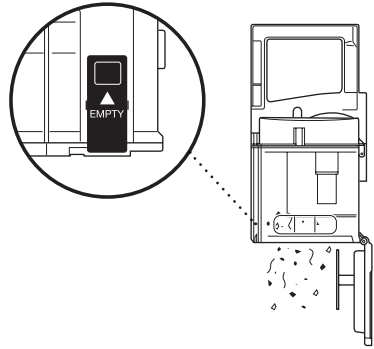

- 3** Hold the dust cup over a trash bin and press the EMPTY button. The bottom lid will open, allowing the debris to fall out.

MAINTENANCE

⚠ WARNING: Hand wash filters with water only to prevent damage from cleaning chemicals. Allow ALL filters to dry completely before replacing in the vacuum to prevent liquid from being drawn into electric parts.

.....

RECOMMENDED FILTER CLEANING SCHEDULE:

Pre-Motor Filter Kit

(Foam & Felt)

XFFH400

Clean once a month.

Post-Motor Filter

XEXFH400

Clean once a year.

Filter Access Latch

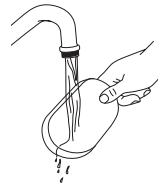
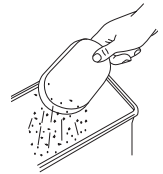
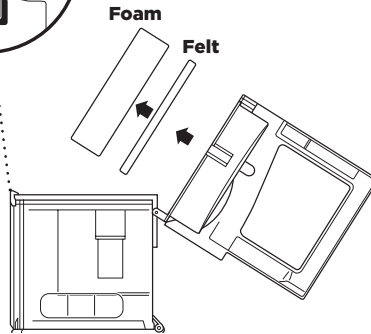
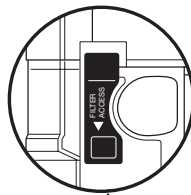

CLEANING THE FILTERS

Pre-Motor Filters

Access the pre-motor filters by pressing the FILTER ACCESS latch on the top of the dust cup. Remove and rinse the foam and felt filters with water. Tap loose dirt off filters between washes as needed. Once completely dry, insert the felt filter first, then place the foam filter on top of it.

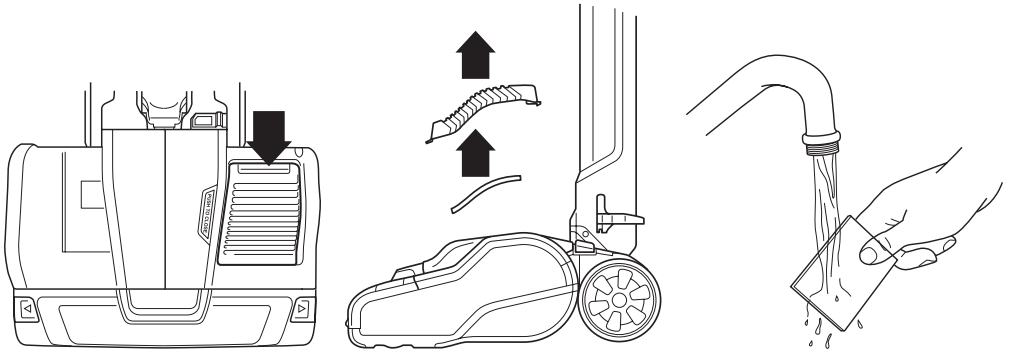

Post-Motor Filter

Access the post-motor filter on top of the floor nozzle. Remove and rinse with water.

MAINTENANCE

⚠ WARNING: To reduce the risk of shock and unintended operation, turn power off and unplug unit before servicing.

★ **IMPORTANT:** Remove brushroll before rinsing.

★ **IMPORTANT:** DO NOT place brushroll in the dishwasher to wash or the dryer to dry. DO NOT submerge brushroll in water.

★ **IMPORTANT:** Using a wet brushroll in the floor nozzle will void your warranty.

DID YOU KNOW?

The brushroll endcap is removable to help clear hair/debris. Ensure the endcap is pressed firmly onto the brushroll to reassemble.

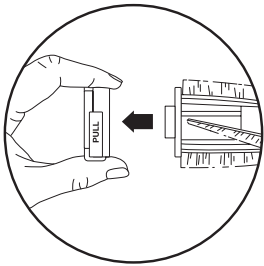

STEP 1

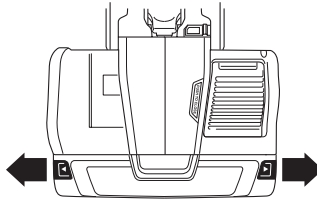

STEP 3

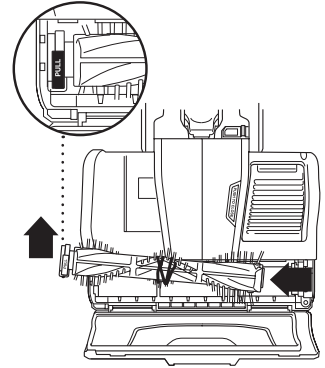

STEP 2

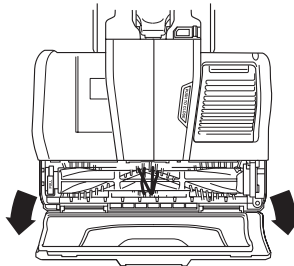

STEP 4

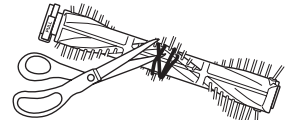

ACCESSING & CLEANING THE BRUSHROLL

- 1 Slide the brushroll garage release buttons out.
- 2 Pull up to open the brushroll garage.
- 3 Lift the endcap on the brushroll up to remove it from the floor nozzle.
- 4 Remove any hair, fibers, or debris wrapped around the brushroll. The groove on the brushroll allows scissors to cut the debris without damaging the bristles.

STEP 5

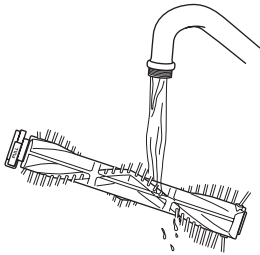

STEP 6

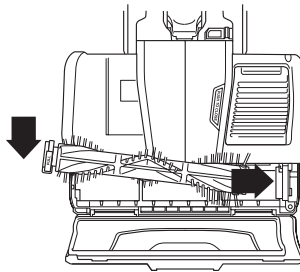

STEP 7

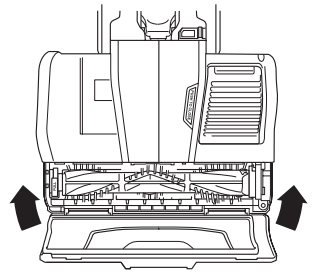

5 The brushroll can be rinsed under running water. Let the brushroll air-dry completely before replacing in the vacuum.

6 To reassemble, hold the brushroll by the endcap and align the other end with the gear. With the endcap facing up, place the brushroll in the floor nozzle.

7 Close the brushroll garage. Listen for a click and make sure the release buttons are fully closed.

NOTE: The brushroll will only spin if the brushroll cover is fully closed and locked.

TROUBLESHOOTING GUIDE

⚠ WARNING: To reduce the risk of shock and unintended operation, turn power off and unplug unit before servicing.

Vacuum is not picking up debris. No suction or light suction.
(Refer to Maintenance section for more information.)

- Check filters to see if they need cleaning. Follow instructions for rinsing and completely air-drying the filters before reinserting in the vacuum.
- Dust cup may be full; empty dust cup.
- Check floor nozzle for blockages; clear blockages if required.
- Remove any string, carpet fibers, or hair that may be wrapped around the brushroll.

Vacuum lifts area rugs.

- Suction is powerful. Take care when vacuuming area rugs or rugs with delicately sewn edges.
- Turn off the unit to disengage the brushroll and restart with the Power slider switch.
- Open the Suction Control slider on the floor nozzle to decrease suction power.

Brushroll does not spin.

- If Brushroll Indicator Light on the floor nozzle turns red, the brushroll has stopped spinning. Immediately turn off and unplug vacuum and remove blockage. Re-plug the unit into an electrical outlet and turn vacuum on.
- If Brushroll Indicator Light on the floor nozzle is green, the blockage has been successfully cleared. If the light is still red, please contact customer service at 1-800-798-7398.
- Check to make sure the brushroll was replaced correctly if it had been removed.
- Ensure brushroll garage of the floor nozzle is closed completely.
- With the power on, recline the wand, which will automatically turn on the brushroll.

Brushroll garage will not close.

- Make sure the brushroll was reinserted correctly with the word “PULL” on the endcap facing up.

Brushroll will not fit back inside the nozzle.

- Make sure the brushroll endcap is pressed firmly onto the brushroll.

Dust cup will not latch back onto floor nozzle.

- Make sure both the brushroll garage and filter access are fully closed. Press firmly in the center of the dust cup on the floor nozzle until you hear a click. The unit will not run until the dust cup is closed and locked.

Vacuum turns off on its own or indicator light flashes red.

This vacuum is equipped with a motor-protective thermostat so the vacuum will shut off if it overheats. Should this occur, perform the following steps to restart the thermostat:

1. Turn vacuum off and unplug it.
2. Empty dust cup and clean filters (see Maintenance section).
3. Check for blockages on the brushroll and remove all hair and carpet fibers.
4. Allow unit to cool for a minimum of 45 minutes.
5. Plug in vacuum and turn it on.

Shark | NINJA FIVE (5) YEAR LIMITED WARRANTY

The 5-Year Limited Warranty applies to purchases made from authorized retailers of **SharkNinja Operating LLC**. Warranty coverage applies to the original owner and to the original product only and is not transferable.

SharkNinja warrants that the unit shall be free from defects in material and workmanship for a period of 5 years from the date of purchase when it is used under normal household conditions and maintained according to the requirements outlined in this instruction manual, subject to the following conditions and exclusions.

What is covered in my warranty?

1. The original unit and/or non-wearable components deemed defective, in SharkNinja's sole discretion, will be repaired or replaced for up to 5 years from the original purchase date.
2. In the rare event that a replacement unit is issued, the warranty coverage ends six months following the receipt date of the replacement unit or the remainder of the existing warranty, whichever is greater. If the unit is replaced, SharkNinja reserves the right to replace the unit with one of equal or greater value.

What is not covered in my warranty?

Our Customer Care/Product Specialists are available to provide all the warranty service options available to you including the possibility of upgrading to our VIP Warranty Service Options for select product categories.

1. Normal wear and tear of wearable parts such as foam filters, HEPA filters, pads etc., which require regular maintenance and/or replacement to ensure the proper functioning of your unit are not covered by this warranty.
2. Any unit that has been tampered with or used for commercial purposes.
3. SharkNinja will cover the cost for the customer to send in the unit to us for repair or replacement. A fee of \$19.95 for return shipping costs will be charged at the time of return shipment of the repaired or replacement unit.
4. Damage caused by misuse, abuse, or negligent handling, or damage due to mishandling in transit.
5. Consequential and incidental damages.
6. Defects caused by or resulting from damages from shipping or from repairs, service, or alteration to the product or any of its parts which have been performed by a repair person not authorized by SharkNinja.
7. Products purchased, used or operated outside of North America.

Problems with your unit/How to get service

If your appliance fails to operate properly while in use under normal household conditions within the warranty period, visit sharkclean.com for product care/maintenance self-help. Our customer care and product specialists are also available at 1-800-798-7398 to assist with product support and warranty service options.

How to initiate a warranty claim

You must first activate your warranty by registering your unit online at sharkclean.com/customersupport. (Note: Purchases made directly from SharkNinja are automatically registered with us and the warranty activated.) Alternatively you can call 1-800-798-7398 to have a customer care specialist assist you. Please note you must call 1-800-798-7398 to initiate a warranty claim. Return and Packing Instruction information will be provided at that time.

The customer care line is open Monday-Saturday, 7am-11pm ET and Sunday, 9am-8pm ET.

Replacement parts are available for purchase at sharkclean.com. For more information on what is classified as wearable and non-wearable parts, please visit sharkwarranty.com.

This warranty gives you specific legal rights, and you also may have other rights that vary from state to state.

Some states do not permit the exclusion or limitation of incidental or consequential damages, so the above may not apply to you.



SharkNinja Operating LLC
US: Newton, MA 02459
CAN: Ville St-Laurent, QC H4S 1A7
1-800-798-7398
sharkclean.com

Illustrations may differ from actual product. We are constantly striving to improve our products; therefore the specifications contained herein are subject to change without notice.

Shark and Rocket are registered trademarks of SharkNinja Operating LLC.

For SharkNinja U.S. Patent information, visit www.sharkninja.com/USPatents

