

SharkTM

FAN

FA200 Series

OWNER'S GUIDE



IMPORTANT SAFETY INSTRUCTIONS

SUITABLE FOR OUTDOOR USE & HOUSEHOLD USE ONLY.

⚠️ WARNING

TO REDUCE THE RISK OF FIRE, ELECTRIC SHOCK, OR INJURY: READ ALL THESE INSTRUCTIONS BEFORE USE.

- This appliance is operated by a rechargeable battery. ONLY recharge the battery with the charger supplied with the unit, battery charger for use only with model GQ36-120300-AUO power supply from Dongguan Gangqi Electronics Co., Ltd. or with model AJJ3-1 from Anlian. A charger that may be suitable for one type of battery may create a risk of fire when used with another battery.
- Do not attempt to destroy, remove, or disassemble the battery pack from the machine. Do not incinerate battery cells. Consult your local waste authority for information regarding available recycling and/or disposal options.
- This appliance comes with a remote control which contains a coin battery. Dispose of batteries properly. Always keep batteries away from children (choke hazard). Even used batteries can cause injury.
- To reduce the risk of electric shock, connect only to an outlet provided with a ground fault circuit interrupting (GFCI) device.
- The fan should be used on a stable and level surface.
- Never use this fan near pools, bathtubs, showers, basins, or other vessels containing water.
- Do not operate any unit with a damaged power supply wire or battery charger. Discard the unit or return to an authorized service facility for examination and/or repair.
- Do not run cord under carpeting. Do not cover charge cord with throw rugs, runners, or similar coverings. Do not route charger cord under furniture or appliances. Keep charger cord away from high-traffic areas. Place charger in an area where the cord will not be tripped over.
- If the charger cord is damaged, it should be replaced.
- This appliance is not intended for use by anyone (including children) with reduced physical, sensory, or mental capabilities, or lack of experience and knowledge, unless they have been given supervision or instruction concerning use of the appliance by a person responsible for their safety.
- Children should be supervised to ensure that they DO NOT play with the appliance.
- Cleaning and user maintenance shall not be made by children without supervision.
- Prior to cleaning or other maintenance, the appliance must be unplugged from the electrical outlet.
- Only use Shark branded accessories.
- Do not use if appliance is not working as it should, or has been dropped, damaged, left outdoors, or dropped into water.
- Turn off all controls before plugging in or unplugging the appliance.
- Unplug from electrical outlet when not in use and before any maintenance or cleaning.
- Hand wash exterior/hard plastic/non-electronic parts with water only. Do not immerse. Cleaning with chemicals could damage the unit.
- Do not attempt to repair or adjust any electrical or mechanical functions of this appliance, as this may cause danger and void the warranty.

BATTERY WARNINGS

- Remove and immediately recycle or dispose of used batteries according to local regulations and keep away from children. Do NOT dispose of batteries in household trash or incinerate.
- Even used batteries may cause severe injury or death.
- Call a local poison control center for treatment information.
- Compatible battery type is CR2025.
- The nominal battery voltage is 3V.
- Non-rechargeable batteries are not to be recharged.

- Do not force discharge, recharge, disassemble, heat above (manufacturer's specified temperature rating) or incinerate. Doing so may result in injury due to venting, leakage or explosion resulting in chemical burns.
- Ensure the batteries are installed correctly according to polarity (+ and -).
- Do not mix old and new batteries, different brands or types of batteries, such as alkaline, carbon-zinc, or rechargeable batteries.
- Remove and immediately recycle or dispose of batteries from equipment not used for an extended period of time according to local regulations.
- Always completely secure the battery compartment. If the battery compartment does not close securely, stop using the product, remove the batteries, and keep them away from children.

⚠️ WARNING: Not suitable for use with solid-state speed controls.

LITHIUM BATTERY SAFETY WARNINGS
LITHIUM BATTERIES STORE A LARGE AMOUNT OF ENERGY AND WILL VENT FIRE OR EXPLODE IF MISTREATED.

- DO NOT DO ANY OF THE FOLLOWING TO THE BATTERY PACK:

a. Open	d. Puncture
b. Drop	e. Incinerate
c. Short-circuit	f. Expose to temperatures
- Keep battery pack dry.
- Charge battery pack only according to its charger's instructions.
- Inspect battery pack before every use: do not use or charge if damaged.

BATTERY REMOVAL AND DISPOSAL

This product contains an integral lithium battery (not replaceable), and the remote control uses a lithium coin battery. When the remote battery no longer has a charge, it should be removed from the remote and recycled. DO NOT incinerate or compost the product with its integral battery or the remote battery. When your remote battery needs to be replaced, dispose of it or recycle it in accordance with local ordinances or regulations. In some areas, it is illegal to place spent lithium batteries in the trash or in a municipal solid waste stream. Return spent battery to an authorized recycling center or to retailer for recycling. Contact your local recycling center for information on where to drop off the spent battery.

POWER SUPPLY SAFETY

- Read and follow all instructions that are on the product or provided with the product.
- Do not use an extension cord.
- Do not use within 10 feet of pool and do not use in a bathroom.
- WARNING: Risk of Electric Shock.** When used outdoors, install only to a covered Class A GFCI protected receptacle that is weatherproof with the power unit connected to the receptacle. If one is not provided, contact a qualified electrician for proper installation. Ensure that the power unit and cord do not interfere with closing the receptacle cover.

FCC WARNINGS

Note: This equipment has been tested and complies with the limits for a Class B digital device - pursuant to part 15 of the FCC Rules. These limits are designed to provide reasonable protection against harmful interference in a residential installation. This equipment generates, uses, and can radiate radio frequency energy, and if not installed and used in accordance with the instructions, may cause harmful interference to radio communications. To see if this equipment interferes with radio or television reception, try turning the equipment off and on.

- To correct any interference:
- Reorient or relocate the receiving antenna.
 - Increase the distance between the equipment and the receiver.
 - Connect the equipment to a different outlet than the receiver.
 - Consult the dealer or an experienced technician for help.
- This device complies with Part 15 of the FCC Rules. Operation is subject to two conditions:
- This device may not cause harmful interference, and
 - this device must accept any interference received, including interference that may cause undesired operation.

Caution: Any changes or modifications to this unit not expressly approved by the party responsible for compliance could void the user's authority to operate the equipment.

WARNING: Not for use with receptacles that are weatherproof only when the receptacle is covered (attachment plug cap not inserted and receptacle cover closed)

WARNING: RISK OF ELECTRIC SHOCK. MOUNT THE UNIT AT A HEIGHT GREATER THAN 0.3 M FROM THE GROUND SURFACE.

⚠️ WARNING: Contains coin battery.

⚠️ WARNING

- INGESTION HAZARD:** This product contains a button cell or coin battery.
- DEATH** or serious injury can occur if ingested.
- A swallowed button cell or coin battery can cause **Internal Chemical Burns** in as little as **2 hours**.
- KEEP** new and used batteries **OUT OF REACH OF CHILDREN**.
- Seek immediate medical attention** if a battery is suspected to be swallowed or inserted inside any part of the body.



BATTERY REMOVAL AND DISPOSAL: This product contains an integral lithium battery (not replaceable), and the remote control uses a lithium coin battery. When the remote battery no longer has a charge, it should be removed from the remote and recycled. Contact your local recycling center for information on where to drop off the spent battery. If the integral fan battery is no longer able to be recharged, it should be recycled. Return un-rechargeable fan (w/integrated battery) to an authorized recycling center or to retailer for recycling, or contact your local recycling center for information on where to drop off spent batteries. **DO NOT** incinerate or compost the product with its integral battery or the remote battery.

READ AND SAVE THESE INSTRUCTIONS

IMPORTANT SAFETY INSTRUCTIONS

SUITABLE FOR OUTDOOR USE & HOUSEHOLD USE ONLY.

CAR CHARGER

1. SAVE THESE INSTRUCTIONS.

This manual contains important safety and operating instructions for battery charger model FA20XCAR from Dongguan City Gangqi Electronics Co., Ltd.

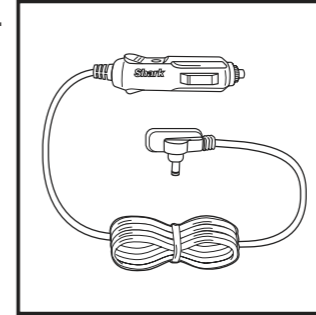

- Before using this battery charger, read all instructions and cautionary markings on the battery charger, battery, and product using battery.
- CAUTION:** To reduce risk of injury, charge only the provided rechargeable battery. Other types of batteries may burst, causing injury to persons and damage.
- Do not** expose charger to rain, moisture, or snow.
- Use of an attachment not recommended or sold by the battery charger manufacturer may result in a risk of fire, electric shock, or injury to persons.
- To reduce damage to car charger and cord, do not attempt to remove the charger from the outlet by pulling the cord. Pull the entire car charger connection from the outlet.
- To reduce risk of electric shock, unplug charger before attempting any maintenance or cleaning. Turning off controls will not reduce this risk.
- Do not** operate the car charger if any components are damaged.
- To clean the charger, first unplug it, then gently wipe it with a damp cloth. Allow the charger to air-dry completely before using it.
- The charger uses a replaceable 5-amp fuse. To remove the fuse, unscrew the chrome knob at the tip of the charging plug. Use only 5-amp fuses for replacement.

FAN COVER

READ ALL INSTRUCTIONS BEFORE USE

The fan cover is not a toy. Children should not play with it as it may become unsanitary during outdoor use.

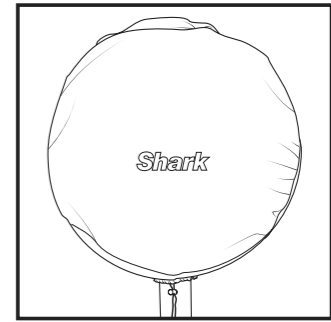

MISTING ACCESSORY

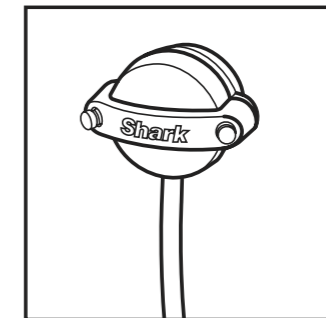
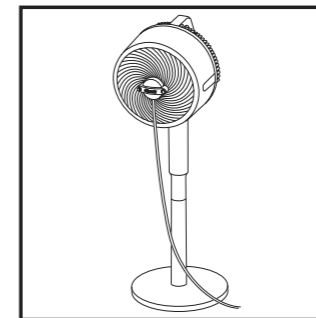

- The misting accessory is suitable for **OUTDOOR USE ONLY**.
- The misting accessory will continue to operate when the fan is powered off. Turn off the water source to turn off the accessory.
- DO NOT** operate the misting accessory using water pressure above typical household pressure, 60 psi.
- DO NOT** use warm or hot water. Only use cold or room temperature water.
- DO NOT** handle live electrical products while in range of the misting stream.

- Keep non-waterproof electronic equipment and appliances out of the misting stream.
- Children should be supervised to ensure that they **DO NOT** play with the misting accessory.
- WARNING: CHOKING HAZARD.** Always keep nozzles and any other small parts out of the reach of children.
- Cleaning and user maintenance of the misting accessory shall not be done by children without supervision.

READ AND SAVE THESE INSTRUCTIONS

WHAT'S INCLUDED



Base

Fan Head
(already assembled)

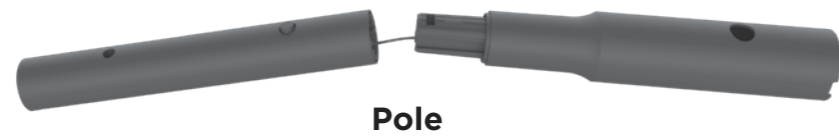

Pole



Remote



Allen Wrench

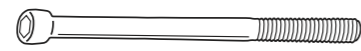

Bolt



Charger

ACCESSORIES

Different fan models come with different accessories. To purchase an accessory that was not included, go to sharkclean.com

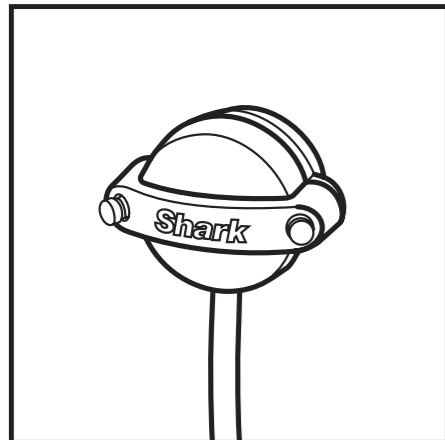

Mister

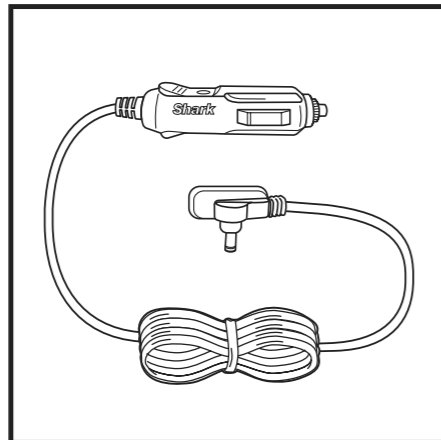

Car Charger

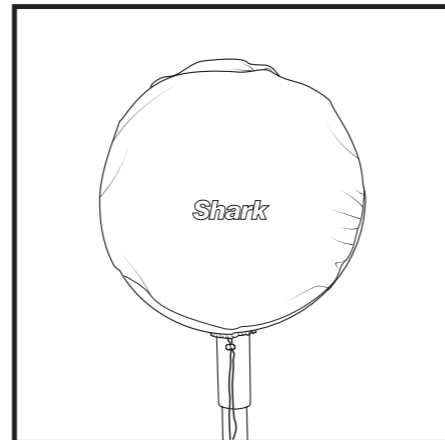

Cover

ASSEMBLING YOUR FAN

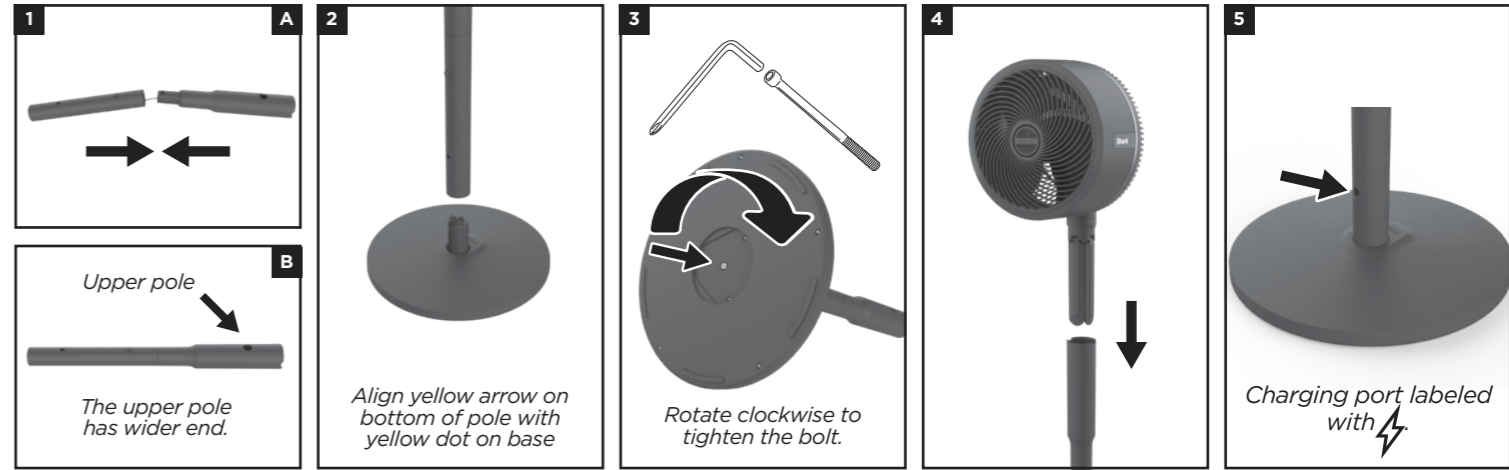

- Align and insert the **Upper Pole** into the **Lower Pole** until it clicks into place.
- Align the yellow dot on the assembled pole with the yellow arrow on the **Base**, then slide the pole down onto the base. Make sure the pole is installed completely and securely.
- Turn the base on its side, then insert the **Bolt** in the bottom of the **Base**. Use the **Allen wrench** to rotate the bolt on the bottom of the base. Rotate the bolt counterclockwise to loosen it, then remove it.
- CAUTION:** finger pinch risk. Holding the fan by the handle, insert the the legs of the fan head into the top of the assembled pole until they click into place.
- Charge fan to 100% battery power** before use without the cord. **First use:** before using remote control, press **Power Button** on fan. Fan is operable while charging.

FEATURES

CORDLESS	OUTDOORS	OSCILLATION	BREEZEBOOST™	REMOTE STORAGE
This is a 2-in-1 fan that can be used with or without the cord.	This fan can be enjoyed indoors or outdoors. DO NOT CHARGE OR USE IN THE RAIN.	This fan offers up to 180 degrees of oscillation as well as up to 55 degrees of vertical tilt.	Activate the extra-powerful BreezeBoost™ for maximum-strength airflow.	Store the remote on the back of the fan head when not in use.

HOW TO USE YOUR FAN

Fan Speeds	Press on the fan head or < > arrows on the remote to switch between fan speeds. LED lights will indicate selected fan speed.	
	BreezeBoost™ Mode	For maximum-strength airflow, press and hold on the fan head for 3 seconds, or press on the remote. During cordless use, fan speed will automatically decrease after 20 minutes to save battery power.
Oscillation	Press on the fan head or < > arrows on the remote to toggle between oscillation settings. LED lights will indicate which setting is selected.	
Horizontal Angle Adjust	Press the < > arrows on the remote to change the horizontal angle of the fan at a distance.	
Runtime	MAXIMUM CORDLESS RUNTIME: 24 hours on fan speed 1. MAXIMUM CORDLESS PERFORMANCE: 2 hours on fan speed 5. PLUGGED IN: Indefinite runtime; fan will charge while operating.	
Charge Time	FROM 0% TO FULLY CHARGED BATTERY: 5 hours	
Battery Indicator	100% charged: white light 51%-99%: green light 21%-50%: amber light 6%-20%: red light steady 5% and below: red light blinking	

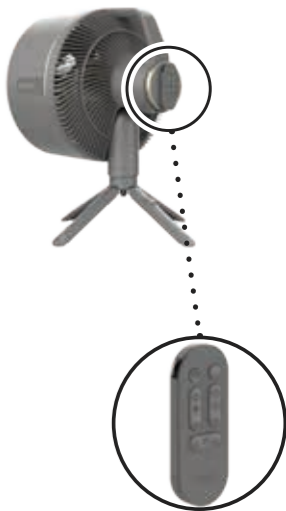

To preserve battery life, the fan will enter IDLE mode if left unplugged and powered off for 24 hours. In IDLE mode, the remote cannot be used to turn on the fan. To turn off IDLE mode, press the power button on top of the fan head.

CHARGING THE FAN

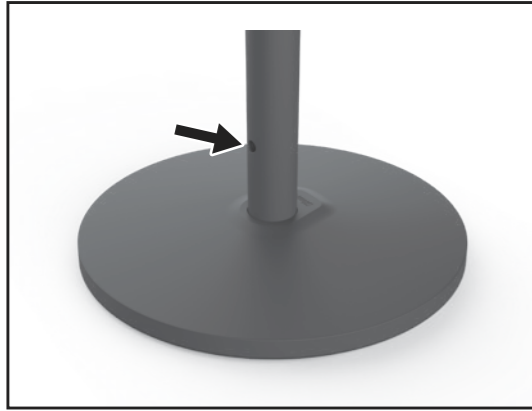

PEDESTAL MODE: To charge the fan in pedestal mode, insert the **CHARGER PLUG** into the charging port near the bottom of the **POLE**.



TABLETOP MODE: To charge the fan in tabletop mode, insert the **CHARGER PLUG** into the charging port under the center shaft of the fan, between the 4 support legs. **DO NOT CHARGE OR USE IN THE RAIN.**

Different fan models have different speed selections. See the charts below for runtime for the 5-speed model and the 3-speed model.

BATTERY LIFE - 5 FAN SPEEDS

Settings	Runtime
Fan Speed 1	24.0 hours
Fan Speed 1 + Oscillation	10.0 hours
Fan Speed 2	14.0 hours
Fan Speed 2 + Oscillation	7.5 hours
Fan Speed 3	6.3 hours
Fan Speed 3 + Oscillation	4.5 hours

Settings	Runtime
Fan Speed 4	3.5 hours
Fan Speed 4 + Oscillation	2.5 hours
Fan Speed 5	2.0 hours
Fan Speed 5 + Oscillation	1.7 hours
BreezeBoost™ Mode	1.5 hours
BreezeBoost™ Mode + Oscillation	1.3 hours

Runtime subject to 10% variability.

BATTERY LIFE - 3 FAN SPEEDS

Settings	Runtime
Fan Speed 1	24.0 hours
Fan Speed 1 + Oscillation	10.0 hours
Fan Speed 2	6.3 hours
Fan Speed 2 + Oscillation	4.5 hours

Settings	Runtime
Fan Speed 3	2.0 hours
Fan Speed 3 + Oscillation	1.7 hours
BreezeBoost™ Mode	1.5 hours
BreezeBoost™ Mode + Oscillation	1.3 hours

Runtime subject to 10% variability.

TABLETOP MODE

To convert the fan to portable, tabletop mode:



To detach the fan from the pole, press the Lift-Away button, then slide the fan head off the pole.



Spread out the four support legs until they click into place. Place the fan on a flat, level surface and begin use.

DISASSEMBLY



1. Release the fan head by pressing the lift away button and carefully remove the fan from the pole.

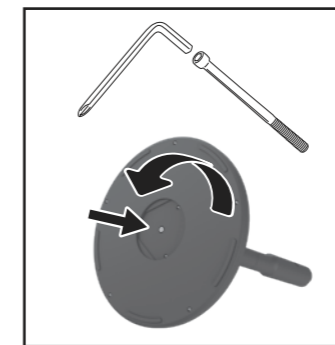

2. Turn the pedestal base on its side to access the bolt on the bottom. Use the included Allen wrench to rotate the bolt counterclockwise, then remove the bolt.

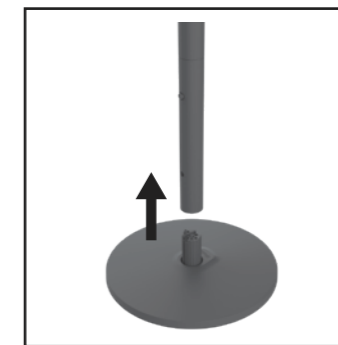

3. Carefully lift the pole to remove it from the base.

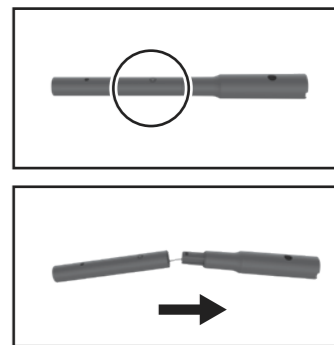

4. Press the small button on the lower pole to detach the poles from one another. Carefully fold as needed for storage. **DO NOT** strain the cord.

If grill screw, bolt, or Allen wrench have been lost, see Hardware Specs section for information on how to replace any hardware.

STORAGE

STORAGE TYPE	INSTRUCTIONS
Short-term storage indoors (<24 hours)	<ol style="list-style-type: none"> Carefully disassemble the fan OR place the assembled fan in the desired storage location. Ensure it is out of reach of children and pets. Place the assembled fan in the desired storage location. Ensure it is out of the reach of children and pets. If there is inclement weather, it is recommended to bring fan indoors.
Long-term storage indoors (>24 hours)	<ol style="list-style-type: none"> Carefully disassemble the fan OR place the assembled fan in the desired storage location. Ensure it is out of reach of children and pets. Store the fan indoors when not in use for long periods of time. Ensure it is stored out of reach of children.

SETTINGS

- Before first use, pull out the plastic tab from the battery compartment of the remote control.
- To preserve battery life, the fan will enter IDLE mode if left unplugged and powered off for 24 hours. In IDLE mode, the remote cannot be used to turn on the fan. To turn off IDLE mode and turn on the power, press the power button on top of the fan head.
- The LED lights on the fan head display will only remain illuminated for 20 seconds after a setting adjustment is made, before turning off to save battery.
- For information on how to activate or deactivate **LOCK MODE** for fan maintenance, please see the Maintenance section.
- Remote may be less effective when used outdoors.

POWER ON/OFF

To turn the fan on or off, press the **POWER** button on the remote or the **POWER** button on the fan head.



5-SPEED MODELS	DISPLAY
ON	<p>LED animations will play once (LEDs will turn on from left to right, then turn off from right to left)</p>
OFF	<p>LEDs will turn off</p>

3-SPEED MODELS	DISPLAY
ON	<p>LED animations will play once (LEDs will turn on from left to right, then turn off from right to left)</p>
OFF	<p>LEDs will turn off</p>

FAN SPEEDS

Changing the **FAN SPEED** will increase or decrease the airflow of the fan. There are 5 fan speed settings.

To change the speed, press the fan icon on the fan head to cycle through the different speeds. With the remote, press the up or down arrows to change speeds.



SPEED	DISPLAY (5-SPEED MODELS)	BEST FOR
1		Quiet operation
2		Moderate cooling
3		Balance of noise level and fan power
4		Air circulation
5		High power cooling

SPEED	DISPLAY (3-SPEED MODELS)	BEST FOR
1		Quiet operation
2		Balance of noise level and fan power
3		High power cooling

BREEZEBOOST™ MODE

Hold for 3 seconds



Turn on BreezeBoost for maximum-power airflow. When operating cordlessly, BreezeBoost will automatically turn off after 20 minutes to save battery. BreezeBoost will run indefinitely when the fan is plugged in.

To activate BreezeBoost, press the **UP ARROW** button on the **REMOTE** or press and hold the fan icon on the fan head for 3 seconds. Repeat to manually deactivate BreezeBoost.

DISPLAY (5-SPEED MODELS)	SPEED	BEST FOR
<p>LED animation will repeat 5 times (LEDs will turn on from left to right)</p>	BreezeBoost	Maximizing fan power

DISPLAY (3-SPEED MODELS)	SPEED	BEST FOR
<p>LED animation will repeat 5 times (LEDs will turn on from left to right)</p>	BreezeBoost	Maximizing fan power



OSCILLATION



Choose between oscillation settings to best suit your needs. 5-speed models have 3 options for angle of oscillation, while 3-speed models have one option.

To change the oscillation settings, press the up/down arrow on the **REMOTE**. To do so on the fan head, press the oscillation  icon to cycle through the settings.

To turn off oscillation, press the down arrow on the remote or the oscillation  icon on the fan head until no LEDs are illuminated.

DISPLAY (5-SPEED MODELS)	ANGLE	BEST FOR
	45°	Circulating air in small area, 1-2 people
	90°	Circulating air in moderate area, 3-4 people
	180°	Circulating air in large area, 5+ people

DISPLAY (3-SPEED MODELS)	ANGLE	BEST FOR
	180°	Circulating air in large area, 5+ people

HORIZONTAL ANGLE ADJUST



You can use the remote control to change the horizontal angle of the fan from a distance. Press the left or right arrows on the remote to adjust the horizontal angle.

CLEANING THE FAN

GENERAL USE	QUESTION	ANSWER
	Why is the remote not working?	When using the remote control, make sure it is pointed directly at the LEDs on the front of the fan. The fan may have entered IDLE mode. To preserve battery life, the fan will enter IDLE mode if left unplugged and powered off for 24 hours. In IDLE mode, the remote cannot be used to turn on the fan. To turn off IDLE mode and turn on the power, press the power button on top of the fan head. If the remote still doesn't work, then try replacing the batteries in the remote.
	Why are the remote and UI buttons not working?	Make sure the fan has battery power by pressing the Power button. If the Battery LED indicator blinks red, then the fan needs to be charged. The fan may be in Lock mode, which deactivates the fan to allow you to safely maintain it. To turn off Lock mode, press the Oscillation () icon on the fan and hold it down for 3 seconds.
	Why is the battery light flashing red when I am trying to turn on BreezeBoost™ mode?	If the battery level is under 10%, BreezeBoost mode cannot be activated. Charge the fan battery to use BreezeBoost.
	Can I leave the fan outdoors?	This fan is water-resistant and will not be damaged by light rain. However, it is not suitable to withstand heavy rain or water submersion. Do not charge or use your fan in the rain.
	Why is the fan rattling?	Ensure that the fan blade cap is fully installed before operating the fan. Please see the Maintenance section for more details.
	The second LED indicator and the Battery LED (in amber) are flashing. What is wrong?	This error state indicates an issue with the voltage of the charger. Please be sure to only use the provided Shark charging cable and power supply.
MAINTENANCE	Why do I have to activate Lock mode before maintenance?	The fan must be in Lock mode when any maintenance is performed. Lock mode prevents the fan from accidentally powering on.
	How often should I clean the fan?	We recommend cleaning the fan every 6 months or as needed.
ACCESSORIES	How often should I clean the misting accessory?	Clean the misting accessory every 12 months or as needed. Please note: the hardness of your water source will impact the frequency at which the misting accessory will need to be maintained.
	Why is the misting accessory not working effectively or not producing mist?	To work properly, the misting accessory must be maintained regularly. See Maintenance section for more information.

TROUBLESHOOTING AND FREQUENTLY ASKED QUESTIONS

We recommend cleaning the fan every 6 months or as needed.

If grill screw, bolt, or Allen wrench have been lost, see the Hardware Specs section for information on how to replace any hardware.

- **LOCK MODE** must be activated prior to performing maintenance. This will temporarily block all fan functions until deactivated. Lock mode prevents the fan from accidentally powering on.

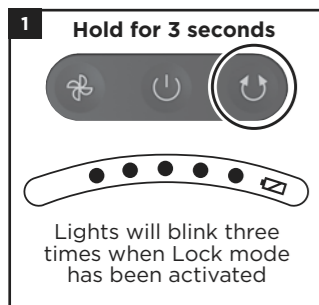

1. Turn on Lock mode before performing maintenance for safety. To activate, hold down the **OSCILLATION** icon on the fan head for 3 seconds.



2. Place the fan upright on a flat, level surface in tabletop mode. Use the Phillips-head end of your Allen wrench to loosen the screw at the bottom of the **FAN GRILL**. Set screw aside.



3. Rotate the **FAN GRILL** counterclockwise to remove it from the fan head. Set grill aside



4. Remove the fan blade cap. Hold the fan blades in place while rotating the fan blade cap clockwise to remove it from the shaft.



5. Gently pull to remove the **FAN BLADES**. With a slightly damp cloth, wipe down the interior parts of the fan.



6. Carefully replace the **BLADES** onto the center shaft.



7. Reinstall the fan blade cap. Hold the fan blades in place while rotating the fan blade cap counterclockwise to reinstall it to the shaft.

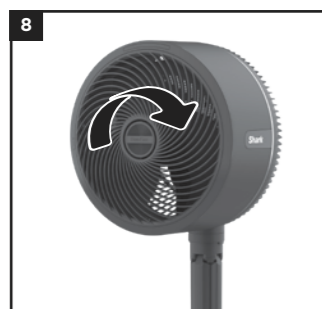

8. Rotate the **FAN GRILL** clockwise to secure it to the fan head.

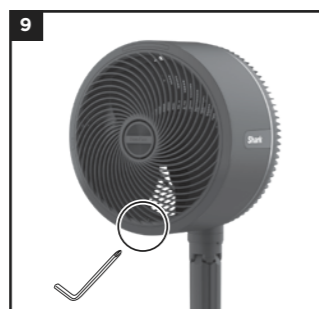

9. Place the fan upright on a flat, level surface. Use the Phillips-head end of your Allen wrench to replace and tighten the screw at the bottom of the **FAN GRILL**.

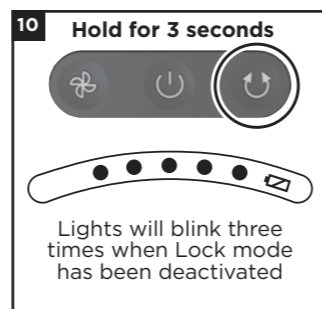

10. Turn off Lock mode by pressing the Oscillation icon for 3 seconds.

HARDWARE SPECS

Grill Screw

For securing the grill to the fan

Drive Type	Phillips
Thread Size / Pitch	M3 x 0.5mm
Length	16mm

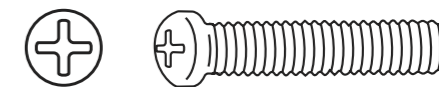

Screwdriver

For driving the screw

Drive Type	Phillips
Size	No. 1

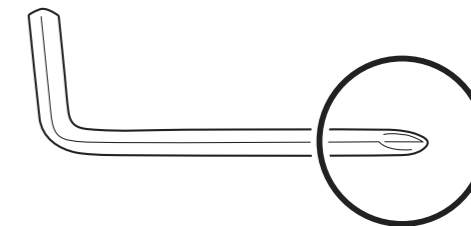

Bolt

For securing base to pole

Drive Type	Hex
Thread Size / Pitch	M6 x 1mm
Length	85mm

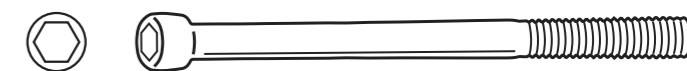

Allen Wrench

For driving the bolt

Drive Type	Hex
Size	5mm

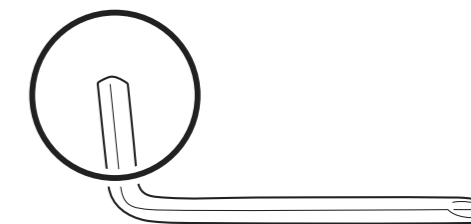

AVAILABLE ACCESSORIES

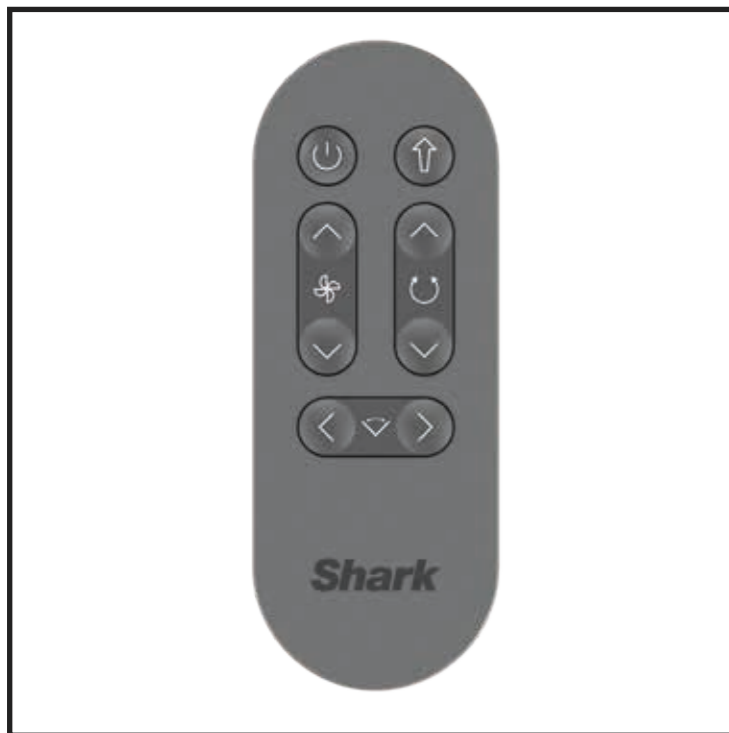

Remote Control

Use the remote control to operate your fan from a distance.

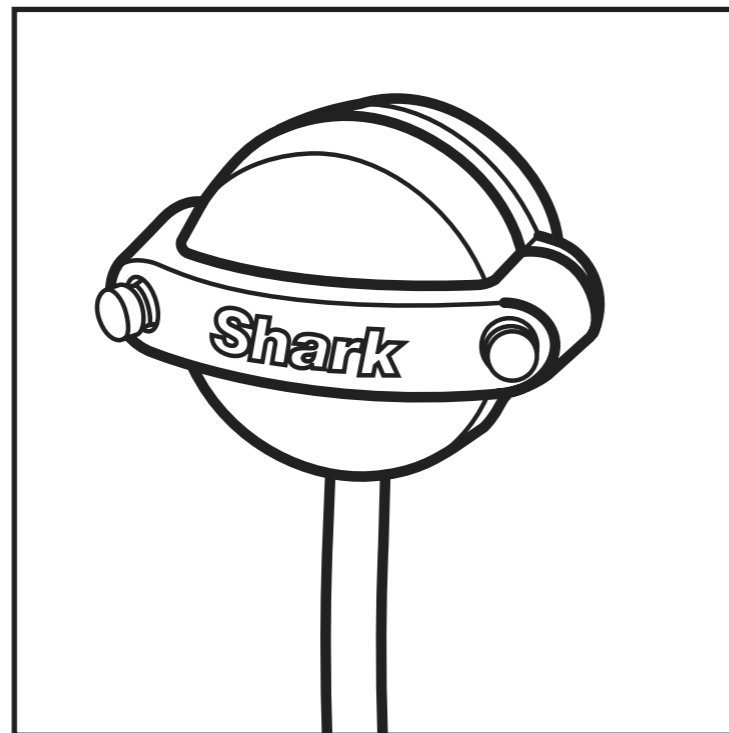

Misting Accessory

Connect the misting accessory to the front grill to produce a fine mist. For assembly instructions and more information, see the Misting Accessory section.

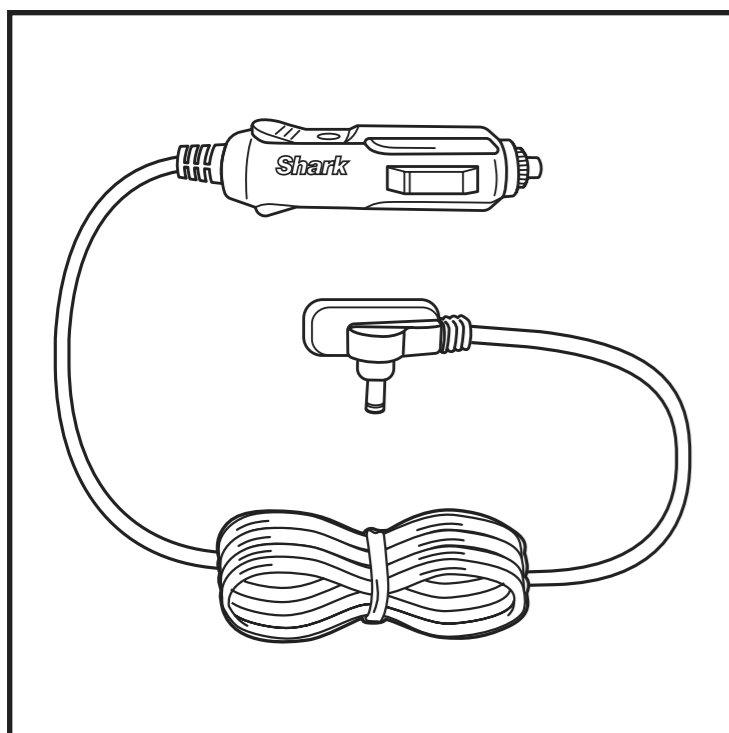

Car Charger

Charge your fan on the go with the car charger accessory. For more information, see the Car Charger section.

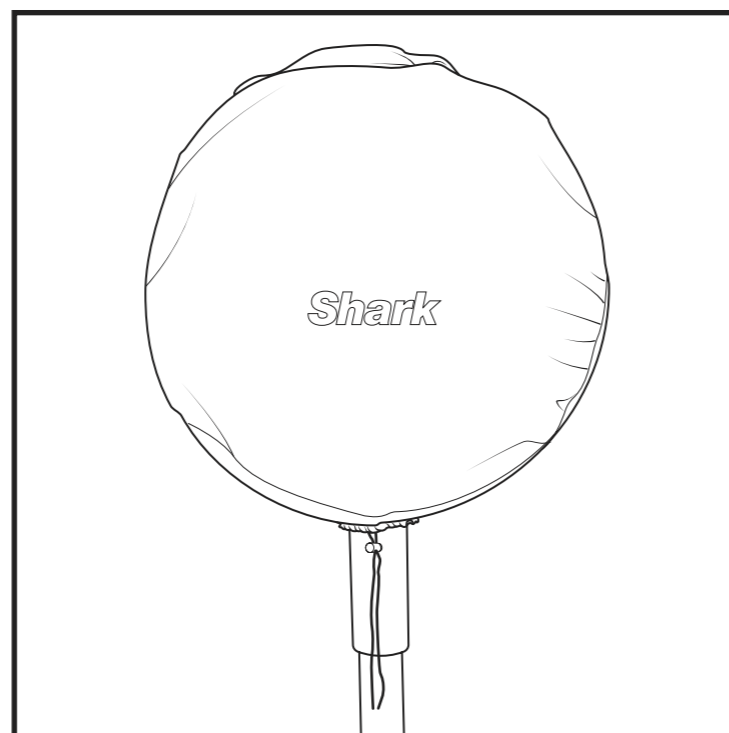

Fan Cover

Protect your fan from damage and dust. For more information, see the Fan Cover section.

MISTING ACCESSORY

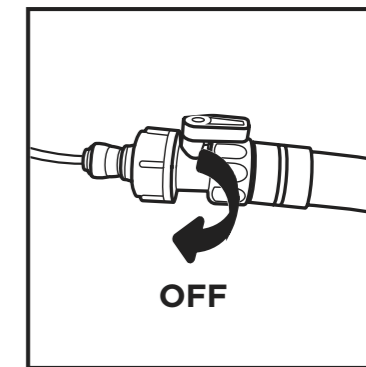
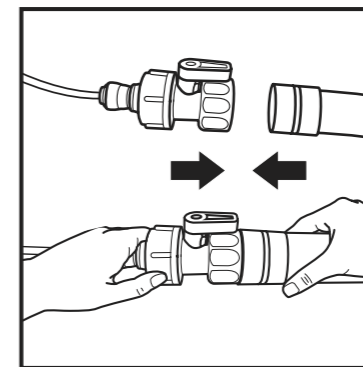
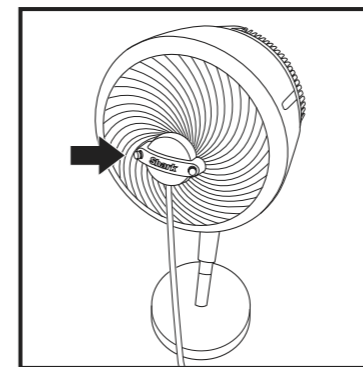

ASSEMBLY:

1. Carefully align the misting accessory with the circle in the center of the fan grill, and push it in to install. Do not use excessive force.
2. Screw the end of the misting accessory into the nozzle of a standard garden hose,
3. Turn on the hose to generate mist.
4. To adjust the amount of mist, increase or decrease the fan speed, or adjust the water pressure from the hose. Higher water pressure or fan speed will produce more mist.
5. The valve is open when the misting accessory is taken out of the packaging. Rotate the valve clockwise to stop the flow of water of water, as shown in the diagram.

If your misting accessory becomes less effective or stops working, follow the steps listed in below. Do NOT twist nozzles unless they are being removed for cleaning

INSTRUCTIONS FOR MAINTENANCE:

FOR BEST RESULTS, CLEAN THE MISTING ACCESSORY ONCE A YEAR, OR AS NEEDED. USING HARDER WATER WILL REQUIRE MORE FREQUENT CLEANING.

1. Turn off the water supply and unscrew the misting accessory from the water source. Remove the other end from the fan grill
2. Unscrew the misting accessory from the water source, then pull the other end of the fan grill.
3. Place the accessory on a flat surface and carefully remove each brass nozzle, one at a time. **CAUTION:** Residual pressure may remain in the misting accessory.
4. To remove a nozzle, twist it counterclockwise. Do not use a wrench or any other tool. **WARNING: CHOKING HAZARD.** Keep nozzles out of the reach of children.
5. To flush the misting system, once the nozzles are all removed, connect the accessory to a garden hose or other outdoor water source. Aim the accessory away from yourself or anyone else, then turn on the water and run it through the system for 30 seconds to flush out any debris.
6. Soak the nozzles in a solution of undiluted distilled white vinegar (5% acetic acid by volume) to loosen debris that may be clogging or restricting the nozzle. **DO NOT** soak the nozzles for more than 2 hours.
7. After soaking the nozzles in the solution, rinse them thoroughly with water.
8. Carefully reinstall each nozzle by twisting clockwise until you feel resistance.

IMPORTANT SAFETY INSTRUCTIONS

READ ALL INSTRUCTIONS BEFORE USE

1. The misting accessory is suitable for **OUTDOOR USE ONLY.**
2. The misting accessory will continue to operate when the fan is powered off. Turn off the water source to turn off the accessory.
3. **DO NOT** operate the misting accessory using water pressure above typical household pressure, 60 psi.
4. **DO NOT** use warm or hot water. Only use cold or room temperature water.
5. **DO NOT** handle live electrical products while in range of the misting stream.
6. Keep non-waterproof electronic equipment and appliances out of the misting stream.
7. Children should be supervised to ensure that they **DO NOT** play with the misting accessory.
8. **WARNING: CHOKING HAZARD.** Always keep nozzles and any other small parts out of the reach of children.
9. Cleaning and user maintenance of the misting accessory shall not be done by children without supervision.

READ AND SAVE THESE INSTRUCTIONS

INSTRUCTIONS FOR USE:

1. Firmly insert the car charger plug into a 12-volt outlet in your vehicle.
2. Insert the charger connector into the charging port on the underside of the fan head, between the 4 support legs.
3. If the fan is charging in a moving vehicle, be sure to position the fan in a secure location.

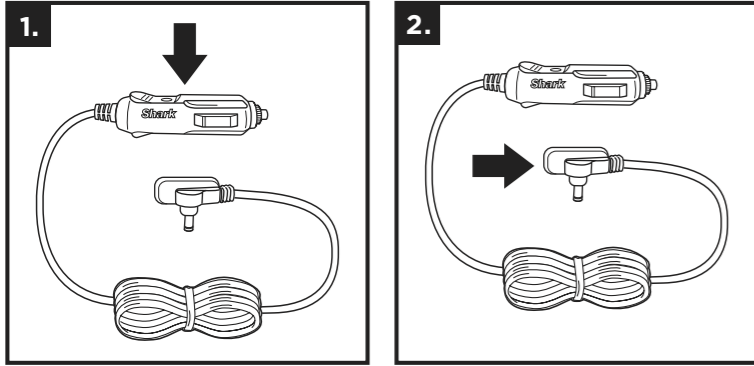

⚠ IMPORTANT SAFETY INSTRUCTIONS

READ ALL INSTRUCTIONS BEFORE USE

1. **SAVE THESE INSTRUCTIONS.** This manual contains important safety and operating instructions for battery charger model FA20XCAR from Dongguan City Gangqi Electronics Co., Ltd.
2. Before using this battery charger, read all instructions and cautionary markings on the battery charger, battery, and product using battery.
3. **CAUTION:** To reduce risk of injury, charge only the provided rechargeable battery. Other types of batteries may burst, causing injury to persons and damage.
4. **Do not** expose charger to rain, moisture, or snow.
5. Use of an attachment not recommended or sold by the battery charger manufacturer may result in a risk of fire, electric shock, or injury to persons.
6. To reduce risk of damage to cigarette lighter connector and cord, pull by cigarette lighter connector rather than cord when disconnecting charger.
7. To reduce risk of electric shock, unplug charger before attempting any maintenance or cleaning. Turning off controls will not reduce this risk.
8. **Do not** operate charger with damaged cord or cigarette lighter connector. Replace it immediately.
9. The car charger may be wiped clean with water once removed from the power socket. Allow car charger to fully dry prior to use.
10. The car charger contains a 5-amp replaceable fuse. Only replace the fuse with a 5-amp fuse, no higher. To do so, unscrew the chrome knob at the top end of the car charging port to access the fuse.

READ AND SAVE THESE INSTRUCTIONS

FAN COVER

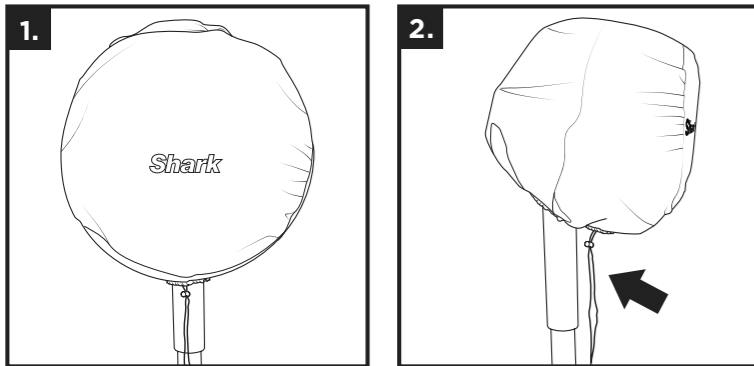

⚠ IMPORTANT SAFETY INSTRUCTIONS

READ ALL INSTRUCTIONS BEFORE USE

1. The fan cover is not a toy. Children should not play with it as it may become unsanitary during outdoor use.

INSTRUCTIONS FOR USE:

1. Position the cover over fan head, then slide it on until the fan is completely covered.
2. Cinch the drawstring on the bottom of the cover to secure it in place.

TWO (2) YEAR LIMITED WARRANTY

The Two (2) Year Limited Warranty applies to purchases made from authorized retailers of **SharkNinja Operating LLC**. Warranty coverage applies to the original owner and to the original product only and is not transferable.

SharkNinja warrants that the unit shall be free from defects in material and workmanship for a period of two (2) years from the date of purchase when it is used under normal household conditions and maintained according to the requirements outlined in the Owner's Guide, subject to the following conditions and exclusions:

What is covered by this warranty?

1. The original unit and/or non-wearable parts deemed defective, in SharkNinja's sole discretion, will be repaired or replaced up to two (2) years from the original purchase date.
2. In the event a replacement unit is issued, the warranty coverage ends six (6) months following the receipt date of the replacement unit or the remainder of the existing warranty, whichever is later. SharkNinja reserves the right to replace the unit with one of equal or greater value.

What is not covered by this warranty?

1. Normal wear and tear of wearable parts (such as batteries, etc.), which require regular maintenance and/or replacement to ensure the proper functioning of your unit, are not covered by this warranty. Replacement parts are available for purchase at sharkaccessories.com.
2. Any unit that has been tampered with or used for commercial purposes.
3. Damage caused by misuse, abuse, negligent handling, failure to perform required maintenance (e.g., not replacing the filters), or damage due to mishandling in transit.
4. Consequential and incidental damages.

5. Defects caused by repair persons not authorized by SharkNinja. These defects include damages caused in the process of shipping, altering, or repairing the SharkNinja product (or any of its parts) when the repair is performed by a repair person not authorized by SharkNinja.
6. Products purchased, used, or operated outside North America.

How to get service

If your appliance fails to operate properly while in use under normal household conditions within the warranty period, visit sharkclean.com/support for product care and maintenance self-help. Our Customer Service Specialists are also available at **1-855-523-4061** to assist with product support and warranty service options, including the possibility of upgrading to our VIP warranty service options for select product categories. So we may better assist you, please register your product online at registeryourshark.com and have the product on hand when you call.

SharkNinja will cover the cost for the customer to send in the unit to us for repair or replacement. A fee of \$25.95 (subject to change) will be charged when SharkNinja ships the repaired or replacement unit.

How to initiate a warranty claim

You must call **1-855-523-4061** to initiate a warranty claim. You will need the receipt as proof of purchase. We also ask that you register your product online at registeryourshark.com and have the product on hand when you call, so we may better assist you. A Customer Service Specialist will provide you with return and packing instruction information.

How state law applies

This warranty gives you specific legal rights, and you also may have other rights that vary from state to state. Some states do not permit the exclusion or limitation of incidental or consequential damages, so the above may not apply to you.

IMPORTANT INFORMATION

REGISTER YOUR PURCHASE

registeryourshark.com

Scan QR code using mobile device



BATTERY REMOVAL AND DISPOSAL

This product contains an integral lithium battery (non-replaceable), and the remote control uses a lithium coin battery (replaceable). **DO NOT** incinerate or compost the product with its integral battery or the remote battery. When the fan battery can no longer hold a charge, dispose of it or recycle it (with integral battery) in accordance with local ordinances or regulations. Remove, replace, and dispose of or recycle the spent remote battery likewise. In some areas, it is illegal to place spent lithium batteries in the trash or in a municipal solid waste stream. Return spent battery to an authorized recycling center or to retailer for recycling. Contact your local recycling center for information on where to drop off the spent battery.



FCC WARNINGS

Note: This unit has been tested and found to comply with FCC limits for Class B digital devices. These limits are designed to provide reasonable protection against harmful interference in a residential installation. This unit generates, uses, and can radiate radio frequency energy, and if not installed and used in accordance with the instructions, may cause harmful interference to radio communications.

This device complies with part 15 of the FCC Rules. Operation is subject to the following two conditions: (1) this device may not cause harmful interference, and (2) this device must accept any interference received, including interference that may cause undesired operation.

To see if this unit interferes with radio or television reception, try turning it off and on.

To correct any interference:

- Reorient or relocate the receiving antenna.
- Increase the distance between the unit and the receiver.
- Connect the unit to a different outlet than the receiver.
- Consult the dealer or an experienced technician for help.

Caution: Any changes or modifications to this unit not expressly approved by the party responsible for compliance could void the user's authority to operate it.

RECORD THIS INFORMATION

Model Number: _____

Serial Number: _____

Date of Purchase: _____
(Keep receipt)

Store of Purchase: _____

TECHNICAL SPECIFICATIONS

Voltage: 120V~ 60Hz / 3A
Watts: 36W
4000 mAh

Benefits of registering your product and creating an account:

- Get easier, faster product support and access to warranty information
- Access troubleshooting and product care instructions
- Be among the first to know about exclusive product promotions

TIP: You can find the model and serial numbers on the QR code label on the underside of the fan head.

PLEASE READ CAREFULLY AND KEEP FOR FUTURE REFERENCE.

This Owner's Guide is designed to help you get a complete understanding of your new Shark® fan.

SharkNinja Operating LLC
US: Needham, MA 02494
CAN: Ville St-Laurent, QC H4S 1A7
1-800-798-7398
sharkclean.com

Illustrations may differ from actual product. We are constantly striving to improve our products; therefore the specifications contained herein are subject to change without notice.

This product may be covered by one or more U.S. patents. See sharkninja.com/patents for more information.